

BOZZYS®

BOZZYS®
Lock your safety with "heart"

SAFETY LOCKOUT TAGOUT

CATALOG
(2023)

WENZHOU BOSHI SAFETY PRODUCTS CO.,LTD

Add: Building 3, No.281 Weiqi Road, Yueqing Economic Development
Zone, Yueqing city, Wenzhou, Zhejiang, China
Zip Code: 325600
Tel: 86-577-57155522
Fax: 86-577-62870808
<https://www.oshalock.com>
E-mail: sales02@oshalock.com

WENZHOU BOSHI SAFETY PRODUCTS CO.,LTD

Lock your safety with "heart"

BOZZYS®

COMPANY PROFILE

Founded in 2011, Wenzhou Boshi Safety Products Co.,Ltd (WENZHOU BADYSAFE EQUIPMENT CO.,LTD.) is a professional safety lockouts manufacturer, specializing in safety padlocks, safety valve lockouts, safety cable lockouts, hasp lockouts, circuit breaker lockouts, scaffolding tags, lockout stations and so on.

Our company takes an area of 10000 square meters and have more than 200 employees, including more than 30 technical backbones. Our company invest more than five million RMB to research and develop new products according to market needs every year. And we have acquired

many patents for appearance, function and invention (Circuit breaker switch lockout, Button switch lockout,ect.). We have many products that fill in gaps in China or World, and we acquired CE certificate which is necessary for European market, International explosion-proof certificate IECEX, ATEX certificate, USA PRO65,CE,ROSH ,OSHAS18001 certificate, ISO45001 certificate, ISO19001 certificate.

Our sales team is huge and we are still expanding our team. We sell safety lockout products to more than 75 countries, such as USA, UK, Australia, New Zealand, German, Russia, Poland, Chile, Colombia, Uzbekistan, etc. So far our company has served some companies directly or through agents, include PetroChina, Sinopec, +iatong Tire, Dongfeng Nissan, Huaxin Cement, etc.

Our company learns from other peers in the world and creates advanced manufacturing skill and safety concept, not only focus on new products' research and development, but also pay attention on our products' quality, providing our customers reliable goods and intimate service. We also fight to providing many company workers a professional, standardized and safe working environment.

Our company "Wenzhou Boshi Safety Products Co.,Ltd"registered the trademark in China, the United States, Canada, EU, Russia, South Korea and some South American countries in 2014 via its holding company "Wenzhou Boshi Electric Technology Co.,Ltd". Laid a solid foundation for selling Boshi Safety Lockouts overseas.

Company philosophy:

No martial art is indefectble, while the fastest speed is the only way for long success.

Company purpose:

Dare to think, dare to do, dare to bear.

Company vision:

No security accident caused by human negligence.

Operating principles:

We are a team. We fight and share success together.

Code of conduct:

To be good and honest.

GLOBAL MARKETING















CERTIFICATION



PARTNER



CONTENTS

	LOCKOUT & TAGOUT		VALVE LOCKOUT
	KEY CHARTING SYSTEM		PNEUMATIC LOCKOUT
	SAFETY PADLOCK		CABLE LOCKOUT
	TAGS & SPECIAL PEN		LOCKOUT STATION
	SAFETY LOCKOUT HASP		SAFETY LOCKOUT KIT
	ELECTRICAL LOCKOUT		LEAD BLOCKADE

SAFETY LOCKOUT TAGOUT



SAFETY LOCKOUT TAGOUT

What is LOTO? (Lock out / Tag out = LOTO)

When the equipment or tool is being repaired, maintained or cleaned, the power source related to the equipment need to be cut off, so that the equipment cannot be started, and all energy sources (power supply, hydraulic source, air source, etc.) are turned off.

Lock out	Lockout is using the safety and other equipment to lock the machine to isolate from unauthorized operations and ensuring each worker's safety until the work is finished.
Tag out	Tagout is using for warning the people that the energy source or equipment is locked that can not be operated optionally.
Disconnecting means	One piece or one group equipment can disconnect the energy source or the power supply circuit.
LOTO	In order to ensure that the equipment energy is turned off , the equipment is kept in a safe state. Prevent accidental injury to the staff or related person inside or next to the equipment caused by the equipment being accidentally operated.

Why should use LOTO?

LOTO is in order to prevent the workers from the danger that caused by the machine start accidentally, the equipment launch abnormal, the energy source release when the worker want to repair or maintain it. So that it can keep the workers personal security. The Key of LOTO is to cut off the connection between machine and power source, lock on the source, release residual power.

Regulations and standards for LOTO

China sets national standards for lockout

In 2009, the General Administration of Quality Supervision, Inspection and Quarantine of the People's Republic of China and the China National Standardization Administration issued the national standard GB / T2.2-2009 Safety Requirements for Electrical Equipment Application Sites-Part 2: Safety Measures for Operation in Power-off.

On May 12, 2017, the General Administration of Quality Supervision, Inspection and Quarantine of the People's Republic of China and the National Standardization Administration of the People's Republic of China issued the National Standard GB / T 33579-2017 safety of machinery- control method of hazardous energy -lockout/ tagout. The national standard began machinery on December 1, 2017.

Interpretation of the national standard GB / T33579-2017 on the scheme of lockout/tagout:

Establishing a control system and use LOTO procedures to prevent accidental release or transmission of machine energy.

Requirements of the national standard GB / T33579-2017 on the process of lockout/tagout



The corresponding laws and regulations of major European and American countries on lockout/tagout

American — OSHA (Controlling of dangerous energy(LOTO)) The Control of Hazardous Energy (Lockout/Tagout) 29CFR 1910.147

Australia — OSHA European Decree —(European Regulations on safety and Health at Work) European Agency for Safety and Health at work

EU —(National Factory Standards) National Standard for plant [NOHSC:1010]

SAFETY LOCKOUT TAGOUT

Wenzhou Boshi safety lock products fully comply with the regulations, and the following requirements for safety locks and lockout devices

Requirement	Durable	rugged	standardized	identifiable	other security purposes
Description	It is made of materials that are resistant to various environments	cannot be removed unless use violent force	clear distinction is made by the difference in color, shape, or size	indicating that authorized personnel	using for controlling equipment energy only
BOZZYS Lockout Products	✓	✓	✓	✓	✓

When & Where should use LOTO?

- Daily maintenance, adjustment, cleaning, inspection and commissioning for equipment. Enter into the limited space, hot work, dismantling work and so on in the tower, tank, electrified body, kettle, heat exchanger, pumps and other facilities.
- Operation involving high voltage, including the operation under the high-tension cable.
- Operation require closing the safety system temporary.
- Operation during maintenance and commissioning of non-processing.



LOCKOUT & TAGOUT REQUIREMENTS

- When some persons are authorized to perform the same task, each staff must complete its own lockout and tagout process, rather than others.
- Never authorize others to remove your lockout device.
- Only operate the device that has been locked by safety lockout.
- When you shift, must not arbitrarily terminate the original lockout device listing until the carry personnel is in accordance with the requirements of the lockout tagout, then remove the original lockout or tagout. At the same time, the new carry personnel should confirm the LOTO is safe and reliable before operation.
- Never let your security rely on others' LOTO, always remember use your safety lockout protect yourself.
- Use the correct lockout, so please find the item in the catalog according to the actual situation.
- Make sure that safety lockout is able to withstand the environment in which it is located like dusty, humid and so on.
- Safety lockout and safety tagout should be combined in usage, and can not replace each other.
- Since 2nd January, 1990, whenever the machinery and equipment change, overhaul, remould or innovate, even install new machinery and equipment for the machines and equipment, the energy isolating device and the equipment should be designed to fit the safety lockout and tagout.
- Operators should test the ability control rules at least once a year, ensure the standard procedures and requirements are implemented. The authorized employees perform regular inspection, rather than the staff who perform energy control rules carry out testing.
- If there is a possibility that the storage of energy should be saved to reach the dangerous level. It should continue to be verified, repair or maintain the energy source, until the danger doesn't exist.
- Whenever external maintenance personnel is take part in the maintenance activities within the permission, the site operators and the external operators shall inform lockout or tagout rules to each other.

SAFETY LOCKOUT TAGOUT

THE PROCEDURE OF LOTO (LOCKOUT/TAGOUT)

STEP 1: PREPARE

Prepare to close the source of energy. The type of energy is electric energy, mechanical energy, air energy and so on. Besides the accident this energy cause. Prepare the lockout and tagout.

STEP 2: NOTICE

Notice the person who effect on isolating and protecting the machine and the manager who is working with the machine.

STEP 3: CLOSE

Close the machine or equipment.

STEP 4: LOCK

Lock the closed equipment or machine after make sure that nobody turn on the valve and the switch. Then you can affix on the warning label or lock wittag to avoid operate miss.

STEP 5: TEST

Test all equipment and circuit make certain all of them have been locked out.

STEP 6: MAINTAIN

Maintain the machine according to the applied situation of the equipment.

STEP 7: RECOVER

Recover the equipment and circuit while remove the lockout and tagout. And inform all workers after provide the energy.

We can provide your factory with professional and systematic locking compliance overall service



KEY MANAGEMENT SYSTEM



KEY MANAGEMENT SYSTEM

Function and method of using key tooth

KD Keyed Different

One key can only open one padlock;
Advantages: Your padlock cannot be opened by the key of other padlocks.

KA Keyed Alike

The quantity is determined according to your needs

One key can open all padlocks in the same group;
Advantages: multiple KA groups can be customized, one key can open all padlocks in the same group, but padlocks can not open each other between the multiple KA groups.

MK Master Keyed

The quantity is determined according to your needs

KDMK

The quantity is determined according to your needs

KAMK

The quantity is determined according to your needs

One key can open all padlocks from several KD groups;
Advantages: padlocks from KD groups can be opened by master key.

GMK Grand Master Keyed

One key can open all padlocks from several groups of KD, KA or MK.

KEY MANAGEMENT SYSTEM

THE COLOR OF KEY

We can provide 8 kinds of different colors.



For example, the coat of master key is black, the sub key is uncoated, then can find the master key easily.



Different department use different colors. For example the red padlocks with red keys are allotted to electrical maintenance department; the yellow groups allot fitter department; the blue groups are allotted production department. In this condition, the color can stand for the responsible department, manage easily.



KEY REGISTER MANAGEMENT

We can register the code that laser print on the padlock and key. In the case that you lost the padlock or the key, we can make the new one depend on the code for you.



Key Management System Ordering System Example

- For example: BD-G01-KD, the quantity is 100;
- For example: BD-G01-KA, 200 pieces;
- For example: BD-G01-KDMK, do 2 groups, 300pcs KD each group, have MK keys to open all the 600pcs;
- For example: BD-G01-KAMK, do 3 groups, 300pcs each group, no matter KA within each group or KD within each group, the padlocks between the 3 groups can not open each other, then have MK keys to open all the 900pcs.

Except Jacket padlocks and Laminated padlocks, other padlock series can choose key management systems. If the key management system has more complex requires for groups, please refer to this page or call for consultation.

KEY MANAGEMENT SYSTEM

Selection of key system groups

Zinc alloy cylinder key system groups			
Key system	Groups qty	Max padlock qty in the group	Serial number
KD	none	1-99999	-
MK	6	860	-
	15	710	-
	30	580	-
GMK	6	80	MK3A series
	15	24	MK3B series

Note: If have more complex requires of groups, please call for consultation.

Brass alloy cylinder key system groups			
Key system	Groups qty	Max padlock qty in the group	Serial number
KD	none	1-99999	-
MK	1	36000	00 series
	6	5000	10 series
	30	1000	20 series
GMK	4	6000	GMK3 series
	23	1000	GMK4 series

Note: If have more complex requires of groups, please call for consultation.

SAFETY PADLOCK



CUSTOMIZATION OPTIONS

Product Appearance

Steel/SS Shackle (Dia 6.2mm)	Nylon Shackle (Dia 6.2mm)	SS Cable Shackle (Dia 3.2mm)	Ultrasonic SS Thin Shackle (Dia 4mm)
SS Thin Shackle (Dia 5mm)	Nylon Thin Shackle (Dia 5mm)	SS Thin Shackle (Dia 4mm)	Nylon Thin Shackle (Dia 4mm)

Padlock Label



Padlock Body Shell And Brand

EB	A	B	C	D	E

Individual Packing Box



**BD-G00 SERIES
SAFETY PADLOCK**



Product Features

- The lock body is made of engineering plastic reinforced nylon PA, with an integrated shell design, which is more durable, resistant to temperature difference (-30°C~+120°C) and impact, and the metal shackle is chrome plated.
- Contain "DANGER" and "PROPERTY OF" standard labels on front and back (Can customized luminous PVC labels). Labels language can be customized.
- Resistance of chemical, extreme temperatures and UV rays.
- Can customized self elastic padlock: the lock shackle pops up automatically when unlocking, and the cylinder locks automatically when locking.
- Key retaining to ensure the padlocks are not left unlocked.
- Laser key numbers or print logo on body sides or the front or the back.
- 5 types of body and 8 colors for your choice.

Model Number

BD - G 0 1

Body Color

1: Red	5: Black
2: Yellow	6: White
3: Blue	7: Orange
4: Green	8: Purple

Shackle Specification

Code	Material	Inner Height (mm)	Dia (mm)
0	Steel/SS	38	6.2
1	Nylon	38	6.2
2	Steel/SS	76	6.2
3	Nylon	76	6.2
4	SS cable	cable 150	3.2
5	Steel/SS	25	6.2
5 <input type="checkbox"/> N	Nylon	25	6.2
6	Steel	20	6.2

Note: Shackle standard do steel by default. If require stainless steel shackle, pls tell the sales

Cylinder Material

no code: Zinc alloy cylinder
T: Brass cylinder

Padlock Series

Self Elasticity And Key Retaining

no code: Standard nonself elastic and with key retaining function
Z: Elastic but without key retaining function

Enterprise Code



Zinc alloy cylinder padlock



Brass cylinder padlock

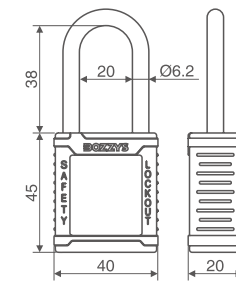

BD-G01/G11

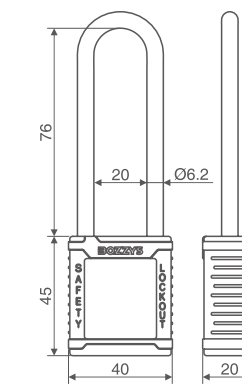

BD-G21/G31

Product Selection

Part Code	Shackle (First digit)			Lock body		Lock cylinder	
	Material	Inner height (mm)	Dia. (mm)	Lock Body	Color (Second digit)	Material	Autoelasticity
BD-G01	Steel/ Stainless Steel	38	6.2	EB type by default other 5 choices A, B, C, D, E	1: Red 2: Yellow 3: Blue 4: Green 5: Black 6: White 7: Orange 8: Purple	Standard Zinc alloy cylinder with 2 keys each lock	standard nonself elastic and with key retaining function
BD-G11	Nylon	38	6.2				
BD-G21	Steel/ Stainless Steel	76	6.2				
BD-G31	Nylon	76	6.2				
BD-G41	Stainless Steel cable	cable 150	3.2				
BD-G51	Steel/ Stainless Steel	25	6.2				
BD-G51N	Nylon	25	6.2				
BD-G61	Steel	20	6.2			can customade Brass cylinder (standard with 1key each lock)	can customade elastic but without key retaining function

Eg: Zinc alloy cylinder padlock model number: BD-G01; Brass cylinder padlock model number: BD-GT01; SS shackle padlock: BD-G01S; Auto-popup padlock: BD-ZG01

Product Appearance



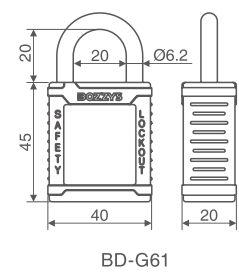
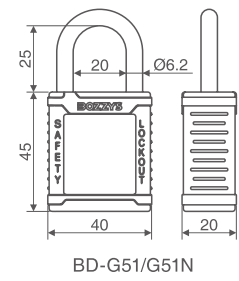
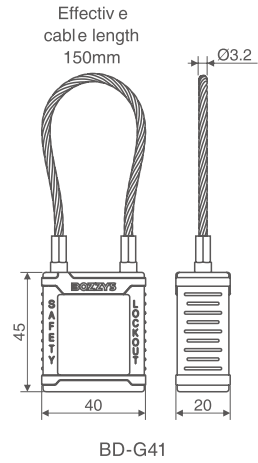

BD-G31	BD-G32	BD-G33	BD-G34	BD-G35	BD-G36	BD-G37	BD-G38
BD-G41	BD-G42	BD-G43	BD-G44	BD-G45	BD-G46	BD-G47	BD-G48
BD-G51	BD-G52	BD-G53	BD-G54	BD-G55	BD-G56	BD-G57	BD-G58
BD-G51N	BD-G52N	BD-G53N	BD-G54N	BD-G55N	BD-G56N	BD-G57N	BD-G58N
BD-G61	BD-G62	BD-G63	BD-G64	BD-G65	BD-G66	BD-G67	BD-G68 /GT68

**BD-G00DP SERIES
SAFETY PADLOCK
(DUST-PROOF COVER)**

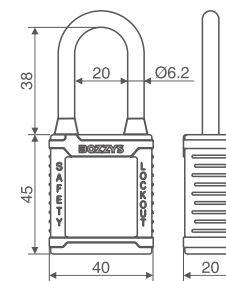

Product Features

- Durable, lightweight with non-conductive PA lock body, withstand temperature from -20 to 150, shock resistance; the shackle is chrome plating; the non-conductive shackle is made from Nylon, ensure the strength and deformation fracture not easily.
- Contain "DANGER" and "PROPERTY OF" standard labels on front and back. Labels language can be customized.
- Resistance of chemical, extreme temperatures and UV rays.
- Key retaining to ensure the padlocks are not left unlocked.
- Laser key numbers or print logo on body sides or the front or the back.
- 5 types of body and 8 colors for your choice.
- Can customized luminous PVC labels.

Product Selection

Part Code	Shackle (First digit)			Lock body		Lock cylinder	
	Material	Inner height (mm)	Dia. (mm)	Lock Body	Color (Second digit)	Material	Autoelasticity
BD-G01DP	Steel/ Stainless Steel	38	6.2	EB type by default other 5 choices A, B, C, D, E	1: Red 2: Yellow 3: Blue 4: Green 5: Black 6: White 7: Orange 8: Purple	Standard Zinc alloy cylinder with 2 keys each lock	standard nonself elastic and with key retaining function
BD-G11DP	Nylon	38	6.2			can customde Brass cylinder (standard with 1key each lock)	can customde elastic but without key retaining function

Eg: Zinc alloy cylinder padlock model number: BD-G01DP; Brass cylinder padlock model number: BD-GT01DP; SS shackle padlock: BD-G01DPS; Auto-popup padlock: BD-ZG01DP

Product Appearance

BD-G01DP	BD-G02DP	BD-G03DP	BD-G04DP	BD-G05DP	BD-G06DP	BD-G07DP	BD-G08DP
BD-G11DP	BD-G12DP	BD-G13DP	BD-G14DP	BD-G15DP	BD-G16DP	BD-G17DP	BD-G18DP

Dust-Proof Cover

- Dust-proof cover made from silica gel ,specially customize for unique padlock body.
- Dust-proof cover suitable for dusty working space.
- Protect key hole from entering dust.



Black dustproof cover



Translucent dustproof cover

Part Code	Description	Cover material	Specification
BD-G01DP-B	Black dustproof cover	Dust-proof silica gel	Specially customize for unique padlock body; Advantage: integrated, removable, soft silica gel to protect padlock body, excellent dust-proof function.

Part Code	Description	Cover material	Specification
BD-G01DP-E	Translucent dustproof cover	Dust-proof silica gel	Specially customize for unique padlock body; Advantage: integrated, removable, soft silica gel to protect padlock body, excellent dust-proof function.

**BD-GP4000 SERIES
SAFETY PADLOCK
(SLIDING COVER DUST
PROOF TYPE)**

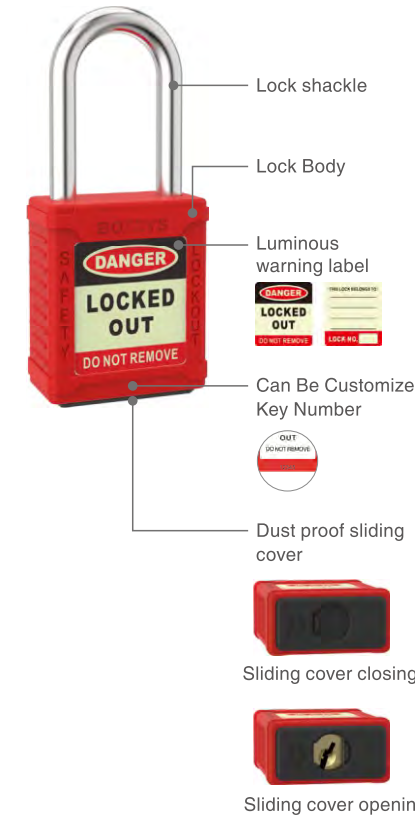

Product Features

- The lock body is made of engineering plastic reinforced nylon PA, with an integrated shell design, which is more durable, resistant to temperature difference (-30°C--+120°C) and impact, and the metal shackle is chrome plated.
- Self developed push-pull dust-proof device for lock hole to prevent dust from entering the lock hole. Suitable for working space environment with large dust.
- Contain "DANGER" and "PROPERTY OF" standard labels on front and back (luminous PVC labels). Labels language can be customized.
- Resistance of chemical, extreme temperatures and UV rays.
- Can customade self elastic padlock: the lock shackle pops up automatically when unlocking, and the cylinder locks automatically when locking.
- Key retaining to ensure the padlocks are not left unlocked.
- Laser key numbers or print logo on body sides or the front or the back.
- 5 types of body and 8 colors for your choice.

Model Number

BD - G P 4 6 1 1

- Enterprise Code
- Padlock Series
- Plastic Body
- Body Width 40-44mm
- Shackle
 - 1: Cable shackle
 - 6: Dia 6.2mm
- Shackle Specification

Code	Material	Inner Height (mm)	Dia (mm)
1	Steel	38	6.2
2	Nylon	38	6.2
3	SS	38	6.2
4	Steel	76	6.2
5	Nylon	76	6.2
6	SS	76	6.2
- Body Color

1: Red	5: Black
2: Yellow	6: White
3: Blue	7: Orange
4: Green	8: Purple

Product Selection

Part Code	Shackle (Third digit)			Lock body		Lock cylinder	
	Material	Inner height (mm)	Dia. (mm)	Lock Body	Color (Fourth digit)	Material	Auto-Pop Up
BD-GP4611	Steel	38	6.2	EB type by default other 5 choices A, B, C, D, E	1: Red 2: Yellow 3: Blue 4: Green 5: Black 6: White 7: Orange 8: Purple	Zinc alloy lock cylinder (Two keys, KD)	Default Non Auto pop With key retaining feature
BD-GP4621	Nylon	38	6.2				
BD-GP4631	Stainless Steel	38	6.2				
BD-GP4641	Steel	76	6.2				
BD-GP4651	Nylon	76	6.2				
BD-GP4661	Stainless Steel	76	6.2				
BD-GP4111	Stainless Steel Cable	Cable length 150	3.2			Brass lock cylinder (One key, KD)	can customized elastic but without key retaining function

Eg: Common padlock: BD-GP4611; Auto-popup padlock: BD-ZGP4611

Product Appearance

BD-GP4611	BD-GP4612	BD-GP4613	BD-GP4614	BD-GP4615	BD-GP4616	BD-GP4617	BD-GP4618
BD-GP4621	BD-GP4622	BD-GP4623	BD-GP4624	BD-GP4625	BD-GP4626	BD-GP4627	BD-GP4628
BD-GP4631	BD-GP4632	BD-GP4633	BD-GP4634	BD-GP4635	BD-GP4636	BD-GP4637	BD-GP4638

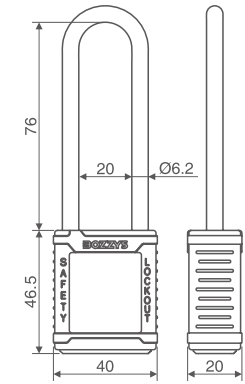

BD-G4641/G4651/G4661

BD-GP4641	BD-GP4642	BD-GP4643	BD-GP4644	BD-GP4645	BD-GP4646	BD-GP4647	BD-GP4648
BD-GP4651	BD-GP4652	BD-GP4653	BD-GP4654	BD-GP4655	BD-GP4656	BD-GP4657	BD-GP4658
BD-GP4661	BD-GP4662	BD-GP4663	BD-GP4664	BD-GP4665	BD-GP4666	BD-GP4667	BD-GP4668
BD-GP4111	BD-GP4112	BD-GP4113	BD-GP4114	BD-GP4115	BD-GP4116	BD-GP4117	BD-GP4118

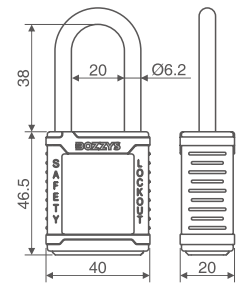

BD-G4611/G4621/G4631

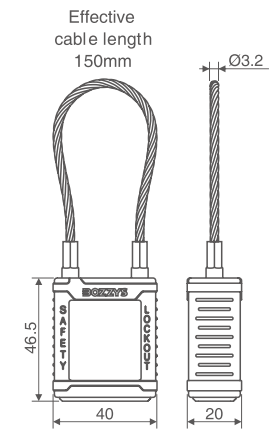

BD-G4111

**BD-SG100 SERIES
SAFETY PADLOCK
(ALUMINUM PADLOCK WITH
RUBBER COATED)**



Product Features

- Lock body is made from aluminum alloy, lightweight, durable, with engineering plastic shell covering outside, UV resistance, corrosion resistance and temperature resistance(-30°C~+120°C).
- Lock shackle is made from steel with chrome plating, tension resistance 1200N when in locking state, silicone tube covering outside, so that the metal is not exposed.
- Brass lock cylinder, can be customized multi-level key management system.
- Key retaining to ensure the padlocks are not left unlocked when the shackle is open.
- Padlock labels can be rewritable, can customized luminous PVC labels.

Product Selection

Part Code	Shackle (The first digit)			Lock Body Color (The third digit)	Lock Cylinder
	Material	Inner height (mm)	Dia. (mm)		
BD-SG101	Steel with silicone tube	38	6.2	1: Red 2: Yellow 3: Blue 4: Green 5: Black 6: White 7: Orange 8: Purple	Brass lock cylinder Non Auto pop With key retaining feature

Product Appearance

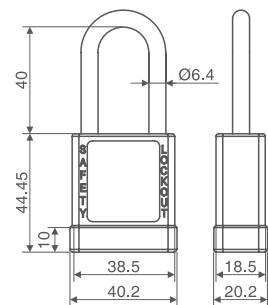

**BD-G300 SERIES
SAFETY PADLOCK
(SMALL TYPE)**



Product Features

- Made from engineering plastic reinforced nylon PA, Integrated housing design, more durable, withstand temperature from -30°C~+120°C, shock resistance; the steel shackle is chrome plating; the nylon shackle is made from DuPont nylon, ensure the strength and deformation fracture not easily.
- Contain "DANGER" and "PROPERTY OF" writable labels, Labels language can be customized.
- UV resistant and corrosion resistant, silicon free.
- Key retaining to ensure the padlocks are not left unlocked when the shackle is open.
- Both sides and front of the lock body can be laser engraved to retain permanent identification or coding.
- A variety of lock bodies and colors are available for your choosing.
- Can customize luminous PVC labels.

Product Selection

Part Code	Shackle (The first digit)			Lock Body		Lock Cylinder
	Material	Inner Height (mm)	Dia. (mm)	Lock Body	Color (The third digit)	
BD-G301	Steel	25	4.7	EB D	1: Red 2: Yellow 3: Blue 4: Green 5: Black 6: White 7: Orange 8: Purple	Brass lock cylinder Non Auto pop With key retaining feature
BD-G311	Nylon					
BD-G321	Aluminum					

Eg: Common padlock: BD-G301; Auto-popup padlock: BD-ZG301

Product Appearance

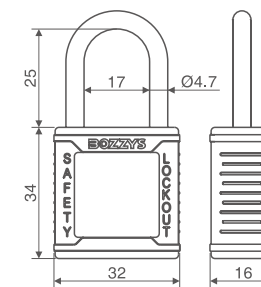

Non Auto pop

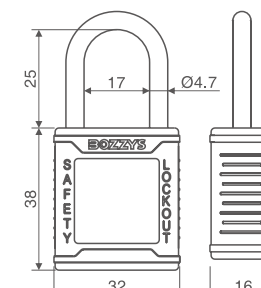

Auto pop



**BD-G700 SERIES
SAFETY PADLOCK
(4MM LOCK SHACKLE TYPE)**



Product Features

- Made from engineering plastic reinforced nylon PA, Integrated housing design, more durable, withstand temperature from -30°C~+120°C, shock resistance; the steel shackle is chrome plating; the nylon shackle is made from DuPont nylon, ensure the strength and deformation fracture not easily.
- Contain "DANGER" and "PROPERTY OF" writable labels, Labels language can be customized.
- UV resistant and corrosion resistant, silicon free.
- Auto pop safety padlock: The lock shackle pops up automatically when unlocking, and the lock cylinder locks automatically when locking.
- Key retaining to ensure the padlocks are not left unlocked when the shackle is open.
- Both sides and front of the lock body can be laser engraved to retain permanent identification or coding.
- Can customize luminous PVC labels.

Product Selection

Part Code	Shackle (The first digit)			Lock Body		Lock Cylinder	Feature (optional)
	Material	Inner Height (mm)	Dia. (mm)	Lock Body	Color (The third digit)		
BD-G701	Stainless steel	38	4	EB	1: Red 2: Yellow 3: Blue 4: Green 5: Black 6: White 7: Orange 8: Purple	Default Brass lock cylinder/ Non auto pop/With key retaining feature	DP (Base dustproof only)
BD-G711	Nylon	38					
BD-G731	Nylon	20					

Eg: Common padlock: BD-G701S; Auto-popup padlock: BD-ZG701S; Dust-proof padlock BD-G701S-DP

Product Appearance

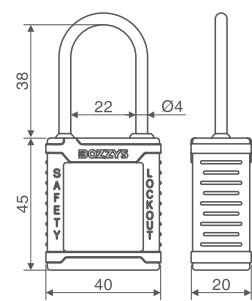

BD-G701/G711

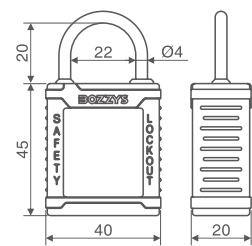

BD-G731

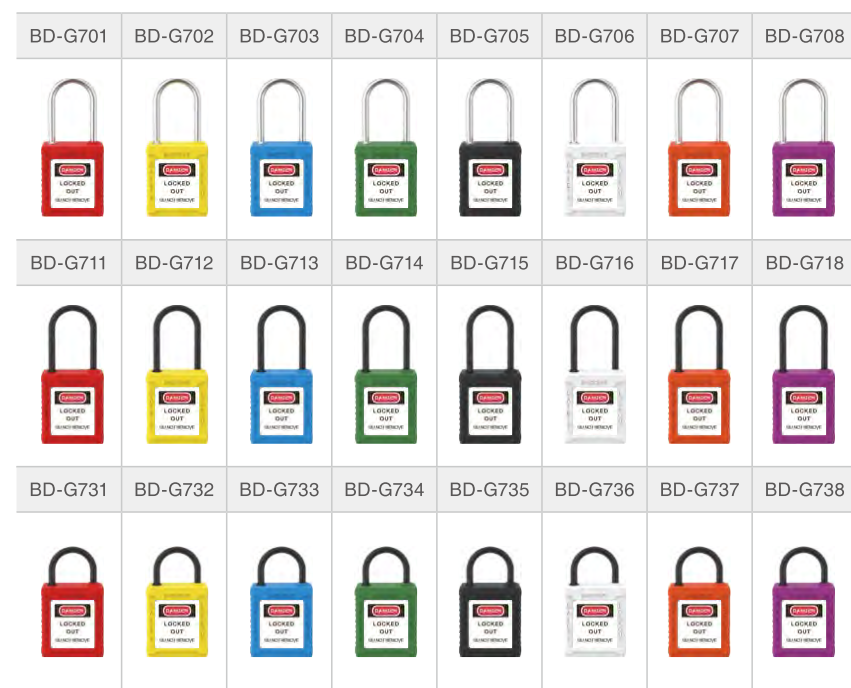

**BD-G800 SERIES
SAFETY PADLOCK
(LONG LOCK BODY TYPE)**



Product Features

- Made from engineering plastic reinforced nylon PA, Integrated housing design, more durable, withstand temperature from -30°C~+120°C, shock resistance; the steel shackle is chrome plating; the nylon shackle is made from DuPont nylon, ensure the strength and deformation fracture not easily.
- Contain "DANGER" and "PROPERTY OF" writable labels, Labels language can be customized.
- UV resistant and corrosion resistant, silicon free.
- Auto pop safety padlock: The lock shackle pops up automatically when unlocking, and the lock cylinder locks automatically when locking.
- Key retaining to ensure the padlocks are not left unlocked when the shackle is open.
- Both sides and front of the lock body can be laser engraved to retain permanent identification or coding.
- Two types of lock bodies and a variety of colors are available for choosing.
- Can customize luminous PVC labels.

Product Selection

Part Code	Shackle (The first digit)			Lock Body		Lock Cylinder	Feature (optional)
	Material	Inner Height (mm)	Dia. (mm)	Lock Body	Color (The third digit)		
BD-G801	Steel/ Stainless steel	38	6.2	EB B	1: Red 2: Yellow 3: Blue 4: Green 5: Black 6: White 7: Orange 8: Purple	Default Zinc lock cylinder/ Non auto pop/With key retaining feature	DP
BD-G811	Nylon	38	6.2				

Eg: Common padlock: BD-G801; Auto-popup padlock: BD-ZGP4611; Dust-proof padlock BD-G801-DP

Product Appearance

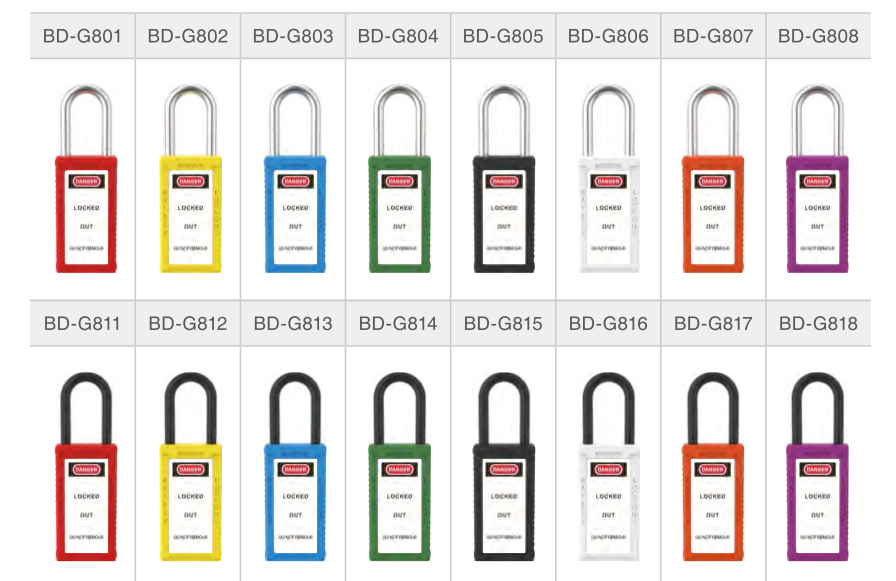
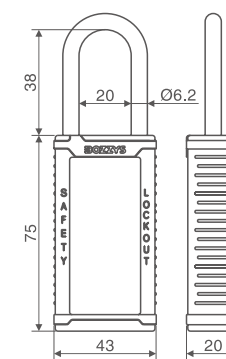

**BD-UG00 SERIES
SAFETY PADLOCK
(ULTRASONIC TYPE)**



Ultrasonic Welding

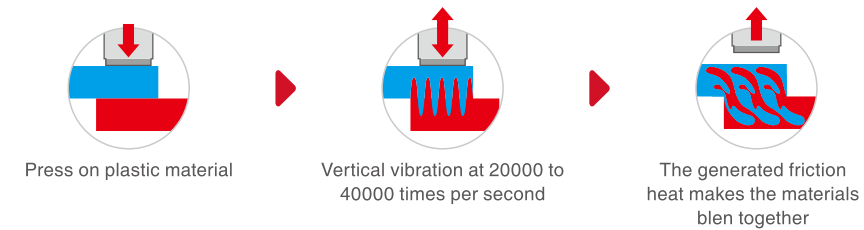

Product Features

- Made from PC+ABS, Integrated housing design, more durable, withstand temperature from -30°C~+120°C, shock resistance; the steel shackle is chrome plating; the nylon shackle is made from DuPont nylon, ensure the strength and deformation fracture not easily.
- Contain "DANGER" and "PROPERTY OF" writable labels, Labels language can be customized.
- UV resistant and corrosion resistant, silicon free.
- Key retaining to ensure the padlocks are not left unlocked when the shackle is open.
- Both sides and front of the lock body can be laser engraved to retain permanent identification or coding.
- Can customize luminous PVC labels.

Product Selection

Part Code	Shackle (The first digit)			Lock Body		Lock Cylinder
	Material	Inner Height (mm)	Dia. (mm)	Lock Body	Color (The second digit)	
BD-UG01	Steel/ Stainless steel	38	6.2	F	1: Red 2: Yellow 3: Blue 4: Green 5: Black 6: White 7: Orange 8: Purple	Zinc lock cylinder/ Non auto pop/ With key retaining feature
BD-UG11	Nylon					

Eg: Common padlock: BD-UG01; Stainless steel shackle safety padlock:BD-UG01S; Auto-popup padlock: BD-ZUG01;

Product Appearance

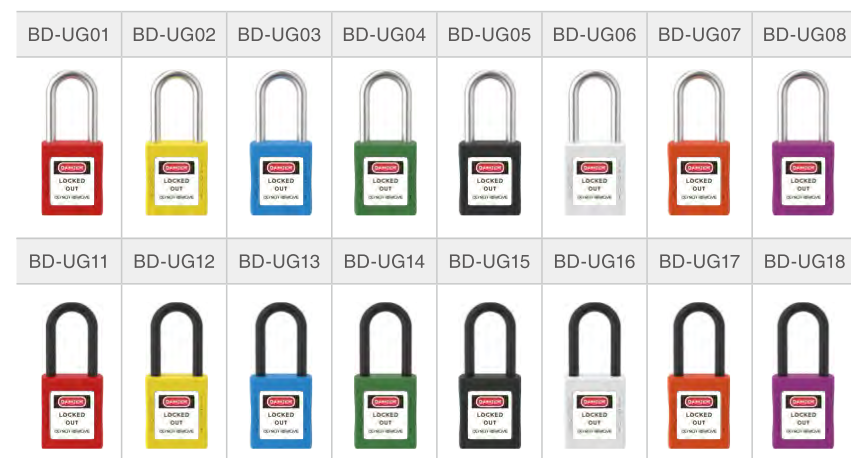
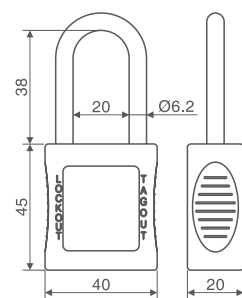

**BD-UG70 SERIES
SAFETY PADLOCK
(ULTRASONIC THIN SHACKLE TYPE)**



Ultrasonic Welding

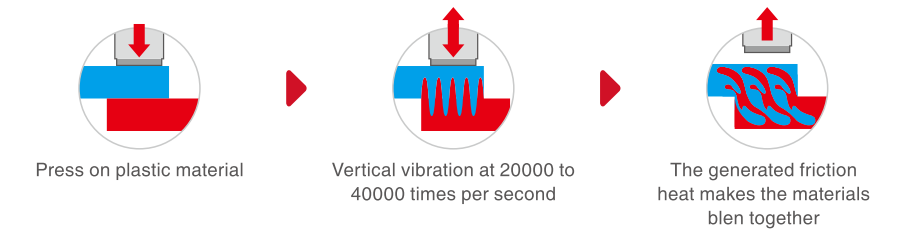

Product Features

- Made from PC+ABS, Integrated housing design, more durable, withstand temperature from -30°C~+120°C, shock resistance; the steel shackle is chrome plating; the nylon shackle is made from DuPont nylon, ensure the strength and deformation fracture not easily.
- Contain "DANGER" and "PROPERTY OF" writable labels, Labels language can be customized.
- UV resistant and corrosion resistant, silicon free.
- Key retaining to ensure the padlocks are not left unlocked when the shackle is open.
- Both sides and front of the lock body can be laser engraved to retain permanent identification or coding.
- Can customize luminous PVC labels.

Product Selection

Part Code	Shackle (The first digit)			Lock Body		Lock Cylinder (optional)
	Material	Inner Height (mm)	Dia. (mm)	Lock Body	Color (The second digit)	
BD-UG71S	Stainless steel	38	4	EB B	1: Red 2: Yellow 3: Blue 4: Green 5: Black 6: White 7: Orange 8: Purple	Default Zinc lock cylinder/ Non auto pop/ With key retaining feature
BD-UG71N	Nylon	38				
BD-UG71ND	Nylon	20				Optional Brass lock cylinder/ Non auto pop/ With key retaining feature

Eg: Common padlock: BD-UG701S; Auto-popup padlock: BD-ZUG71S; Dust-proof padlock BD-UG71S-DP

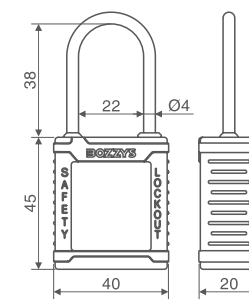

BD-UG71S/UG71N

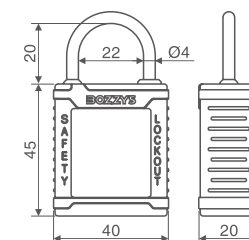

BD-UG71ND

Product Appearance

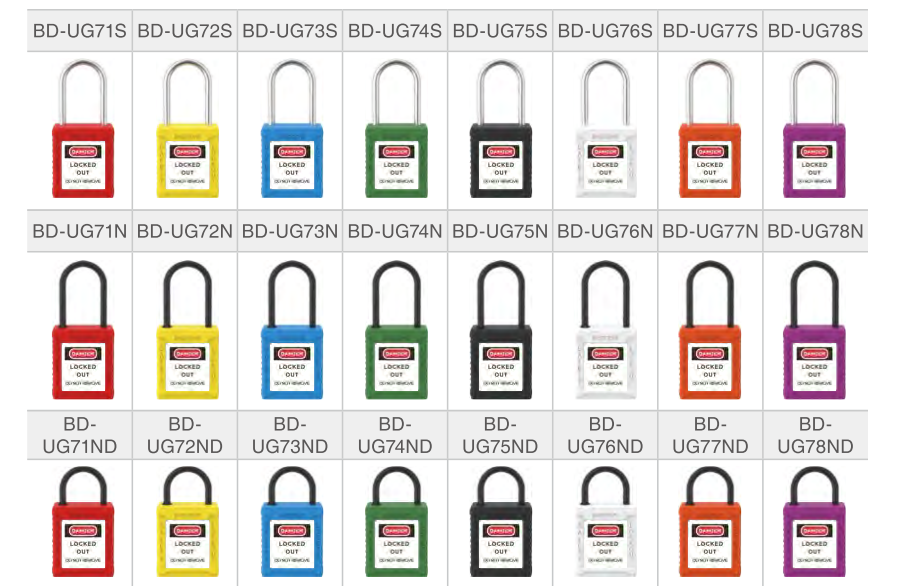

BD-LG80
CABLE SAFETY PADLOCK

Product Features

- Lock body is made from PA66+20%GF, its cable is made from stainless steel with PVC outer layer.
- Technical parameter: pulling force 800N, temperature -30°C~+80°C.
- Brass lock cylinder, can realize multi-level management.
- Cable has two different types, full transparent and black translucent.
- Padlock and cable lockout integrated design, easy to use.
- Have appearance and structure patents.
- It can be used together with BD-P03 tag.
- Chinese and English labels (customizable).

Product Selection

Part Code	Cable			Lock Cylinder
	Material	Dia. (mm)	Cable length	
BD-LG80-3	Stainless steel + PVC coated	3	Default: 0.8mm Other cable length can be customized	Brass lock cylinder
BD-LG80-4		4		

Overall Dimensions

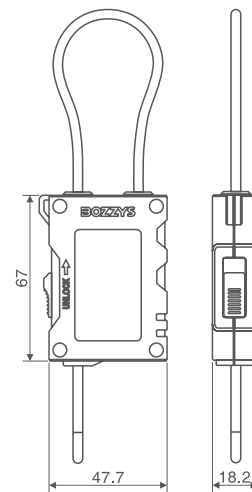

BD-A20D SERIES
ALUMINUM PADLOCK

Product Features

- The lock body is processed and formed by aluminum alloy profiles machine, with anodized surface, bright color, and corrosion resistant metal lock shackle.
- Engrave LOGO, can customize customers' logo.
- UV resistant and corrosion resistant.
- Auto pop safety padlock: The lock shackle pops up automatically when unlocking, and the lock cylinder locks automatically when locking.
- Key retaining to ensure the padlocks are not left unlocked when the shackle is open.
- Both sides and front of the lock body can be laser engraved to retain permanent identification or coding.
- Various colors for choosing.

Product Selection

Part Code	Shackle			Color (The second digit)	Lock Cylinder
	Material	Inner Height (mm)	Dia. (mm)		
BD-A21D	Steel/ Stainless steel	38	6.2	Red	Brass lock cylinder/ Auto pop/ with key retaining feature
BD-A22D				Golden	
BD-A23D				Blue	
BD-A24D				Green	
BD-A25D				Black	
BD-A26D				White	
BD-A27D				Orange	
BD-A28D				Purple	

Note: The default is steel shackle, pls remark stainless steel shackle if need.

Product Appearance

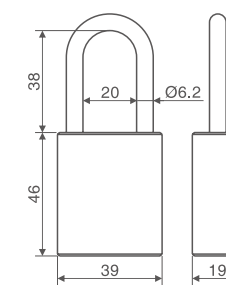
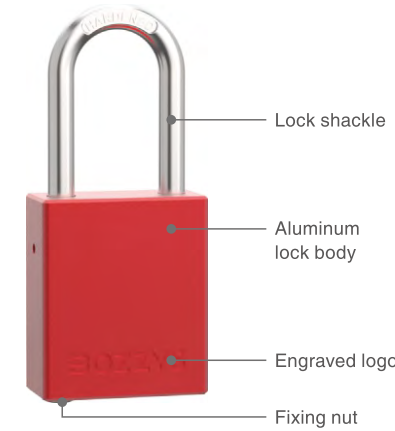

**BD-A30 SERIES
ALUMINUM PADLOCK**



Product Features

- The lock body is processed and formed by aluminum alloy profiles machine, with anodized surface, bright color, and corrosion resistant metal lock shackle.
- Engrave LOGO, can customize customers' logo.
- UV resistant and corrosion resistant.
- Auto pop safety padlock: The lock shackle pops up automatically when unlocking, and the lock cylinder locks automatically when locking.
- Key retaining to ensure the padlocks are not left unlocked when the shackle is open.
- Both sides and front of the lock body can be laser engraved to retain permanent identification or coding.
- Various colors for choosing.

Product Selection

Part Code	Shackle			Color (The second digit)	Lock Cylinder
	Material	Inner Height (mm)	Dia. (mm)		
BD-A31	Steel/ Stainless steel	38	6.2	Red	Brass lock cylinder/ Auto pop/ with key retaining feature
BD-A32				Golden	
BD-A33				Blue	
BD-A34				Green	
BD-A35				Black	
BD-A36				White	
BD-A37				Orange	
BD-A38				Purple	

Note: The default is steel shackle, pls remark stainless steel shackle if need.

Product Appearance

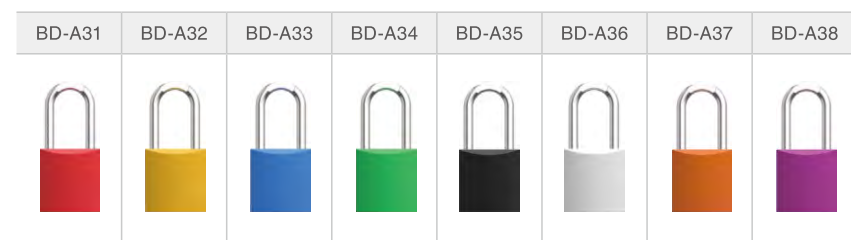
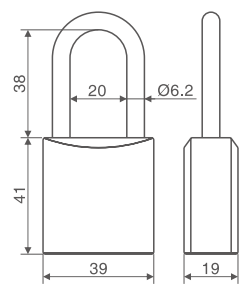

**BD-A40 SERIES
ALUMINUM PADLOCK**

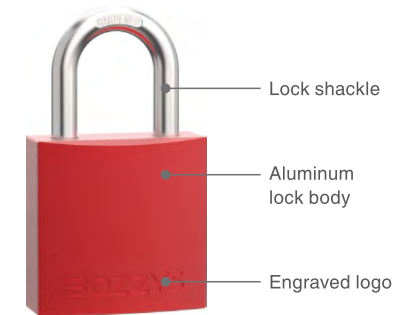

Product Features

- The lock body is processed and formed by aluminum alloy profiles machine, with anodized surface, bright color, and corrosion resistant metal lock shackle.
- Engrave LOGO, can customize customers' logo.
- UV resistant and corrosion resistant.
- Auto pop safety padlock: The lock shackle pops up automatically when unlocking, and the lock cylinder locks automatically when locking.
- Key retaining to ensure the padlocks are not left unlocked when the shackle is open.
- Both sides and front of the lock body can be laser engraved to retain permanent identification or coding.
- Various colors for choosing.

Product Selection

Part Code	Shackle			Color (The second digit)	Lock Cylinder
	Material	Inner Height (mm)	Dia. (mm)		
BD-A41	Steel/ Stainless steel	20	5	Red	Brass lock cylinder/ Auto pop/ with key retaining feature
BD-A42				Golden	
BD-A43				Blue	
BD-A44				Green	
BD-A45				Black	
BD-A46				White	
BD-A47				Orange	
BD-A48				Purple	

Note: The default is steel shackle, pls remark stainless steel shackle if need.

Product Appearance

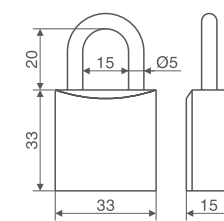

**BD-J10/20/30 SERIES
JACKET SAFETY PADLOCK**



Product Features

- Made of ABS(lock shell), meta(lock body inside),and chrome plated steel shackle.
- With rewritable "DANGER "and" PROPERT: OF"warning label. (Other languages can be customized)
- UV and corrosion resistant.
- Laser printing available, front or flanks.
- 8 colors available.

Product Selection

Part Code	Shackle			Color (The second digit)	Lock Cylinder
	Material	Inner Height (mm)	Dia. (mm)		
BD-J11	Steel	24	6.2	1: Red 2: Yellow 3: Blue 4: Green 5: Black 6: White 7: Orange 8: Purple	Brass lock cylinder
BD-J21		36			
BD-J31		65			

Product Appearance

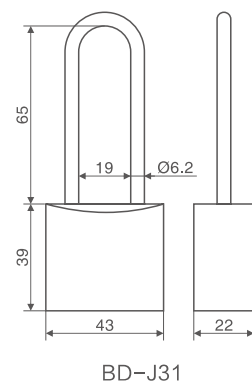
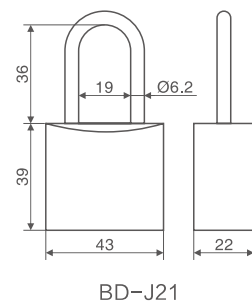
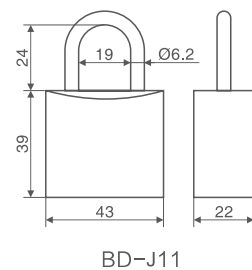

**BD-J40 SERIES
LAMINATED PADLOCK**

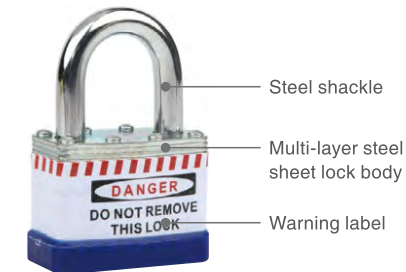

Product Features

- Made of multi-kayer high strength metal steel sheets which surface use zinc plating process,and steel shackle.
- With rewritable "DANGER "and" PROPERT OF"warning label. (Other languages can be customized)
- Suitable for special environment and condition.

Product Selection

Part Code	Shackle			Lock Body			Lock Cylinder		
	Material	Inner Height A (mm)	Inner Width B (mm)	Dia. C (mm)	Material	Inner Width W(mm)		Inner Height H(mm)	Dia. D (mm)
BD-J41	Steel	18	14	5	Steel	33	27	20	Iron Cylinder
BD-J42		24	20	6		43	34	25	
BD-J43		46	20	6		43	34	25	
BD-J44		25	21	7		48	34	26	
BD-J45		30	24	8.7		53	37	29	
BD-J46		61	24	8.7		53	39	29	

Product Appearance



Overall Dimensions

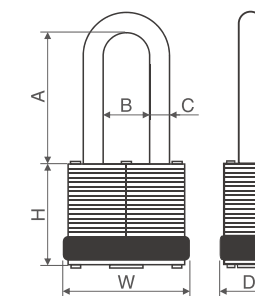

TAGS & SPECIAL PEN

LOCKOUT TAGOUT

Product Introduction

- Lockout tagout can be used to make a holistic control of the equipment to protect workers from accident and equipment from damage.
- Use with safety padlock to remind that the equipment has been locked and can not be operated. It can only be opened by the one who lock it. It enables people to know who has locked it, thereby knowing that operating the equipment is dangerous.
- You can see "Danger/Do not operate/ Caution" etc warnings on the tag and also "Name/department/Date" etc blank for you to fill in.
- Offer language customization.

Product Features

- Polyvinyl chloride (PVC) tag resistant to common industrial chemicals, plastic sealing PET coated tag can prevent grease and dust.
- A tag with the "DO NOT OPERATE" message.
- According to the employee's name, unit, telephone number, etc., for employees to identify.
- Set with 10mm Dia. yellow buttonholes suitable for all types of padlocks and resistant to pressure.

Product Selection

Display		
	Model	BD-P01
Material	PVC	PVC
Thickness	0.4mm	0.3mm

Display		
	Model	BD-P02A
Material	PVC with plastic sealed	PET
Thickness	0.55mm	0.3mm



Customization

- Material: PVC, no-easy tear paper, stainless steel sheet and do on.
- Thickness: 0.3-2.5mm.
- Size: any size.
- Printing requirements: whether plastic coated or not, individual set type, UV rays resistance printing, individual personal photo input and so on.



Application

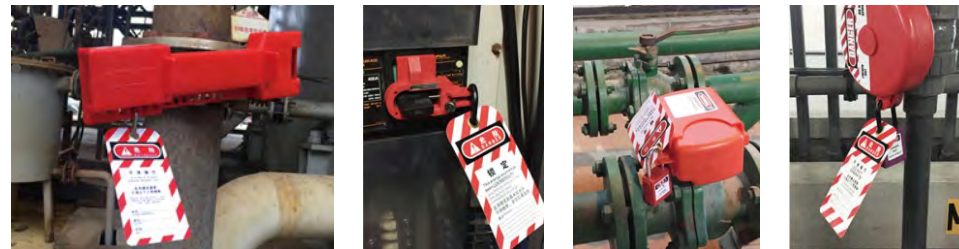

SCAFFOLDING TAG

Product Introduction

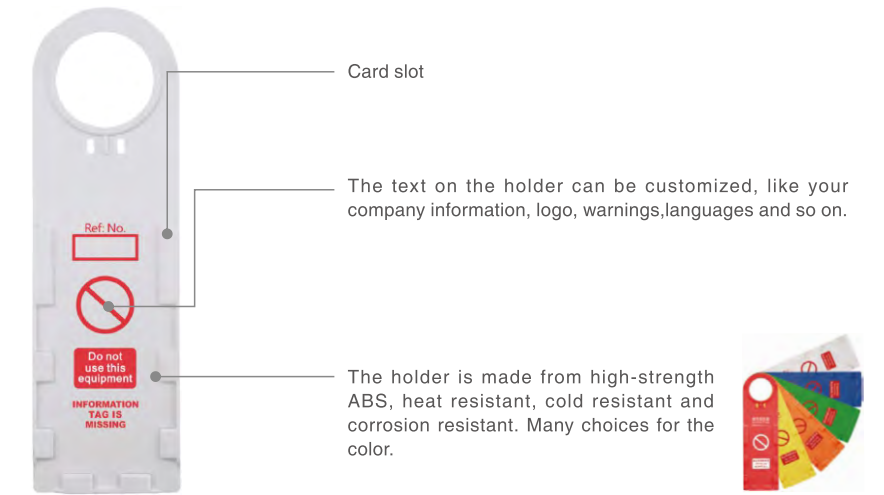

Customization for insert tag: Company information, logo, phone number languages and so on.

Category	Description
SCAFFOLDING HOLDER	Tags can be stuck on the equipment or tied to the wire
TAG	Green card: scaffold is safe, can be used normally. Yellow card: scaffold is breakdown, in the maintenance. Red card (no card): scaffold is for forbidden to use.

**BD-P31
SMALL
MULTIFUNCTIONAL
SCAFFOLDING TAG**

Product Selection

Scaffolding Holder	Tag	Customization

BD-P32
MULTIFUNCTIONAL
SCAFFOLDING TAG

Thickness: 6mm
Weight: 30g

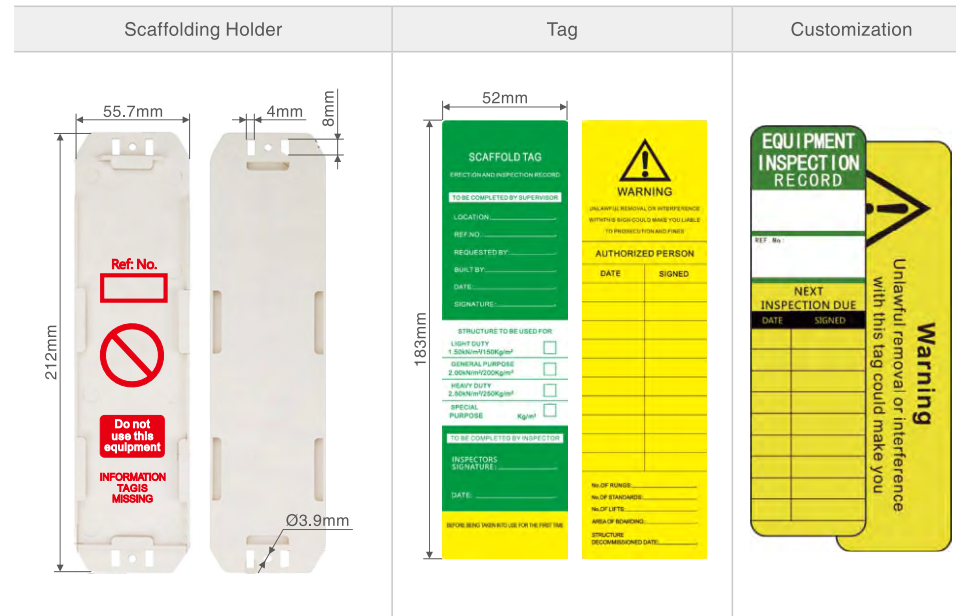

BD-P35
HOOK TYPE
MULTIFUNCTIONAL
SCAFFOLDING TAG

Thickness: 6mm
Weight: 88g

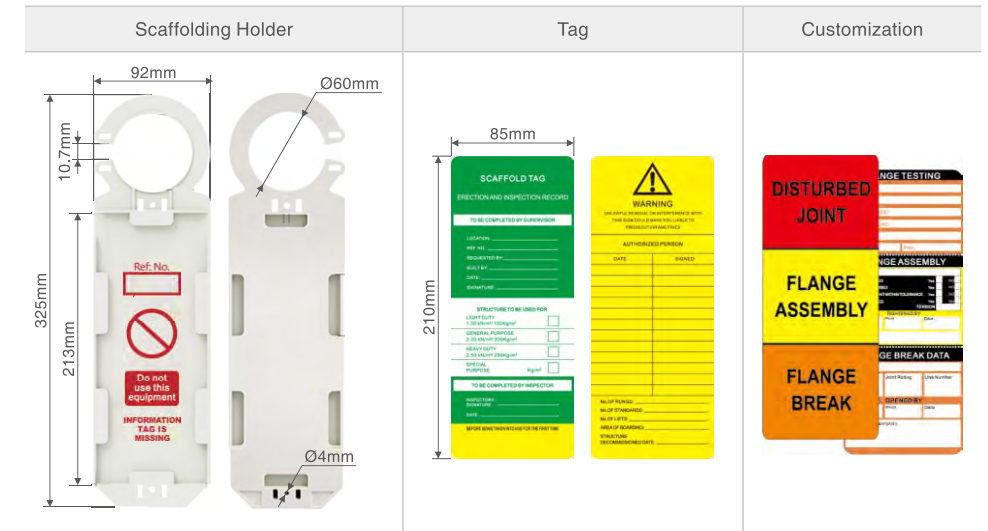

BD-P33
CIRCULAR TYPE
MULTIFUNCTIONAL
SCAFFOLDING TAG

Thickness: 6mm
Weight: 75g

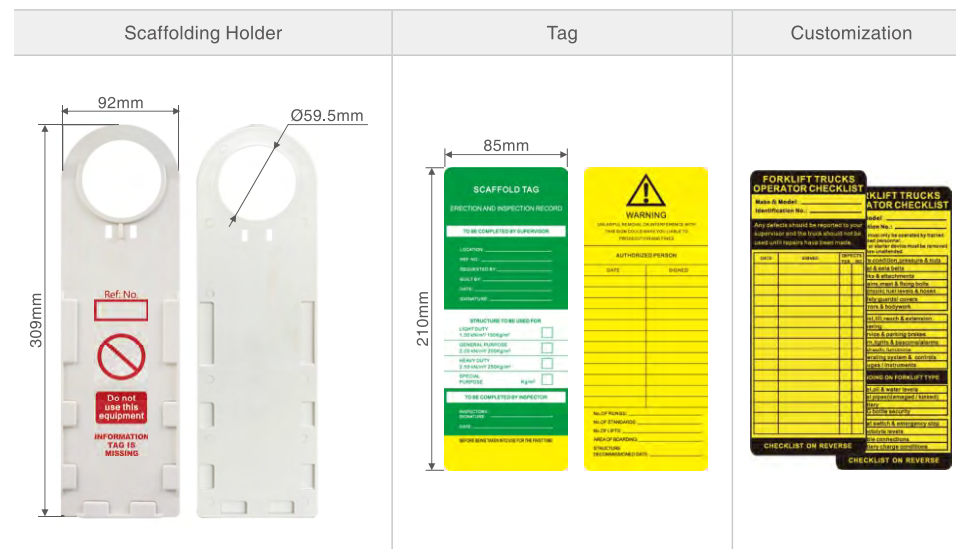

BD-P36
MULTIFUNCTIONAL
SCAFFOLDING TAG

Thickness: 6mm
Weight: 110g

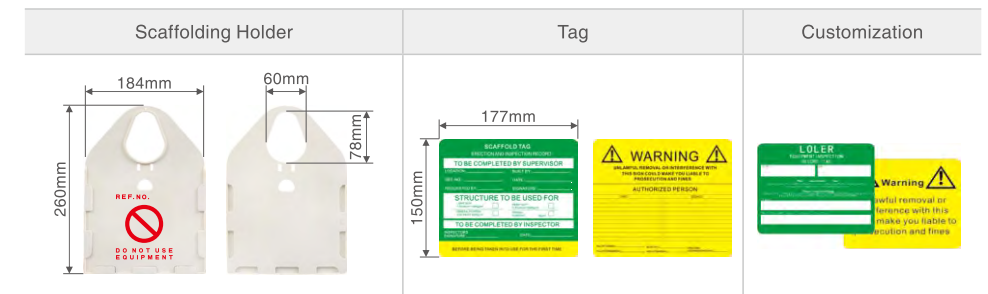

BD-P37
MULTIFUNCTIONAL
SCAFFOLDING TAG

Thickness: 6.5mm

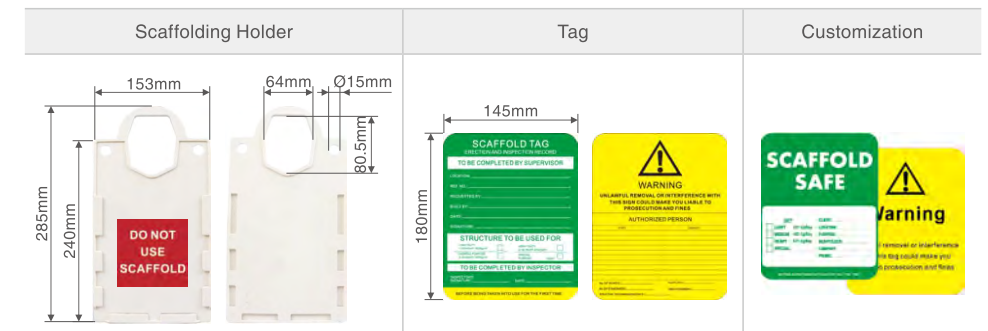

BD-P34
LARGE
MULTIFUNCTIONAL
SCAFFOLDING TAG

Thickness: 6mm
Weight: 88g



BD-P38
CIRCULAR TYPE
MULTIFUNCTIONAL
SCAFFOLDING TAG

Thickness: 6.7mm
Weight: 62.2g

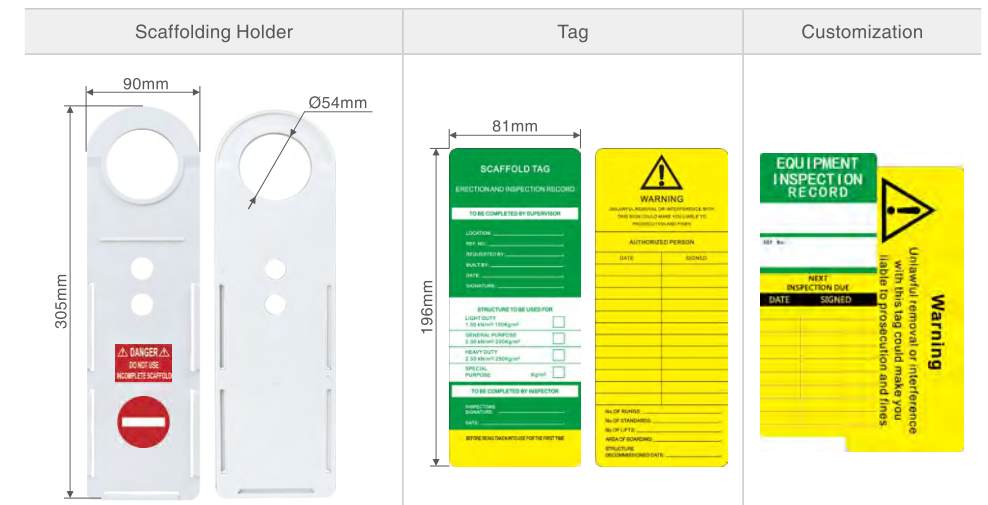

Lock your safety with "heart"

BD-P39
CIRCULAR TYPE
MULTIFUNCTIONAL
SCAFFOLDING TAG

Thickness: 6mm

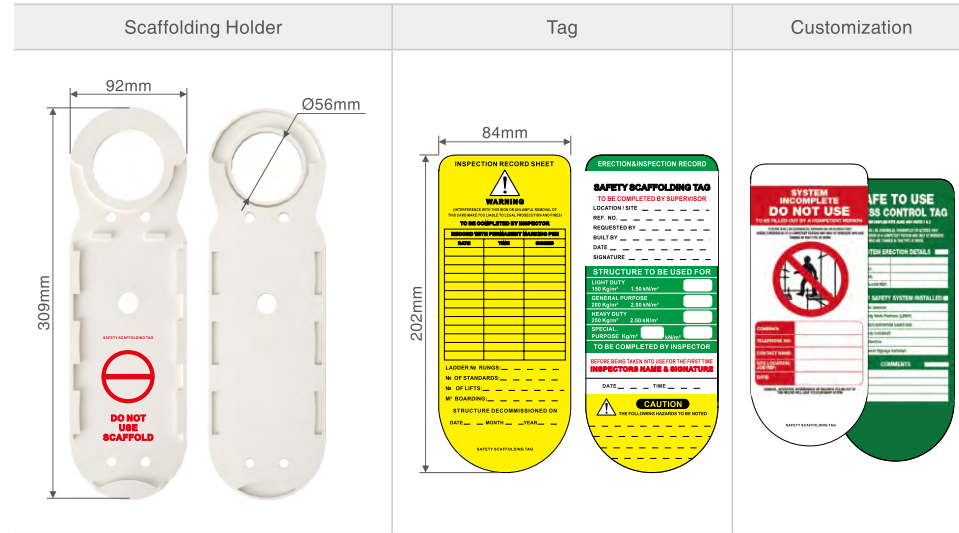

BD-P40
MULTIFUNCTIONAL
SCAFFOLDING TAG

Thickness: 7mm

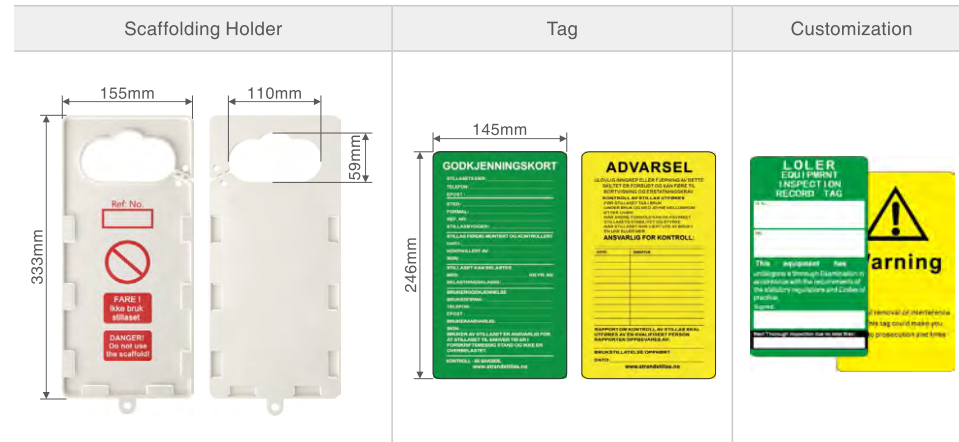

Application

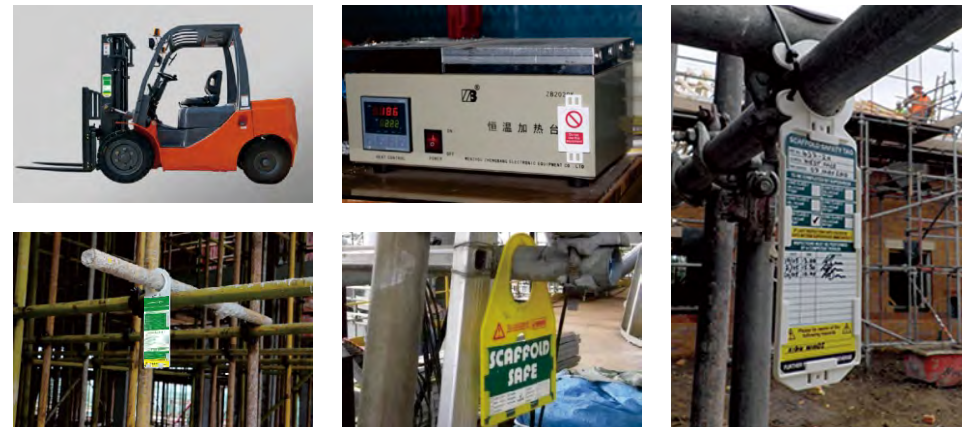

TAGS & SPECIAL PEN



BD-K01/K02
PA COATED STEEL HASP

Unit: mm

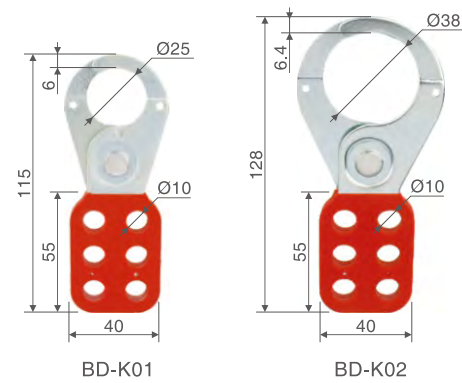

Product Features

- Made of Engineering plastic nylon PA injection molding, galvanized rustproof surface.

Product Selection

Model	Lock hole Dia.	Lock shackle Dia.	Description
BD-K01	10.5mm(2/5")	25mm(1")	Can be accommodated with 6 padlocks(maximum)
BD-K02	10.5mm(2/5")	38mm (1.5")	

BD-K03/K04
ECONOMIC STEEL HASP

Unit: mm

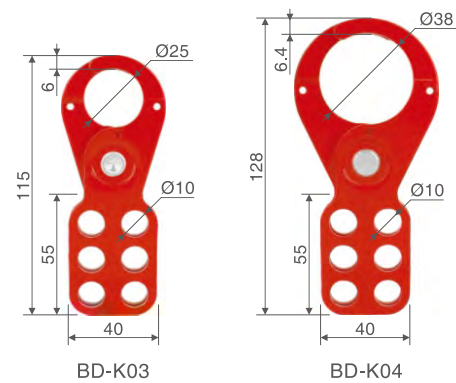

Product Features

- Made of high temperature plastic sprayed steel.

Product Selection

Model	Lock hole Dia.	Lock shackle Dia.	Description
BD-K03	10.5mm(2/5")	25mm(1")	Can be accommodated with 6 padlocks(maximum)
BD-K04	10.5mm(2/5")	38mm (1.5")	

BD-K05
HIGH STRENGTH STEEL HASP

Unit: mm

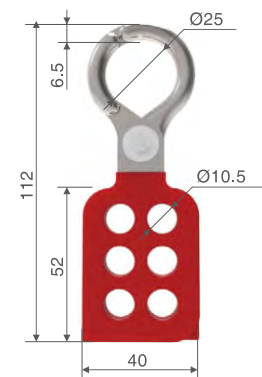

Product Features

- Made of zinc plated steel and PVC dipping handle.

Product Selection

Model	Lock hole Dia.	Lock shackle Dia.	Description
BD-K05	10.5mm(2/5")	25mm(1")	Can be accommodated with 6 padlocks(maximum)

BD-K11/K12
SPARK-PROOF ALUMINUM HASP

Unit: mm

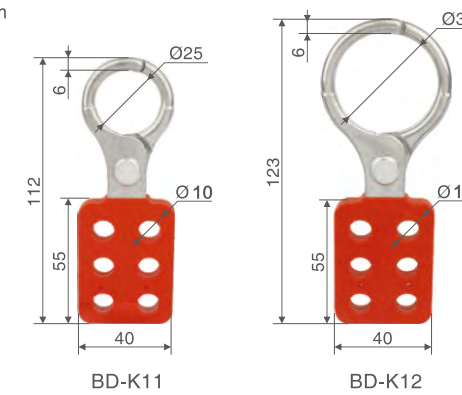

Product Features

- Made of chrome plated aluminum and nylon PA injection molding or PVC dipping handle.

Product Selection

Model	Lock hole Dia.	Lock shackle Dia.	Description
BD-K11	9mm(9/25")	25mm(1")	Can be accommodated with 6 padlocks(maximum)
BD-K12	9mm(9/25")	38mm (1.5")	

BD-K13/K14
SPARK-PROOF ZINC ALLOY HASP

Unit: mm

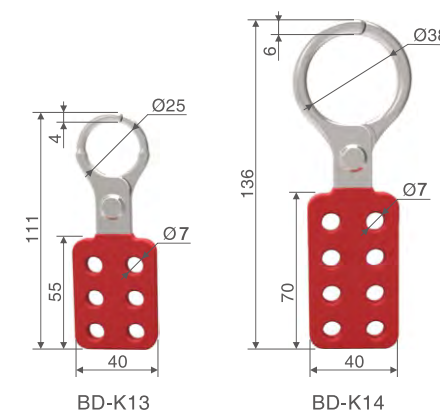

Product Features

- Made of chrome plated zinc alloy and nylon PA or TPE injection molding handle.

Product Selection

Model	Lock hole Dia.	Lock shackle Dia.	Description
BD-K13	7mm(7/25")	25mm(1")	Can be accommodated with 6 padlocks(maximum)
BD-K14	7mm(7/25")	38mm (1.5")	Can be accommodated with 8 padlocks(maximum)

BD-K21/K22
STEEL HASP WITH HOOK

Unit: mm

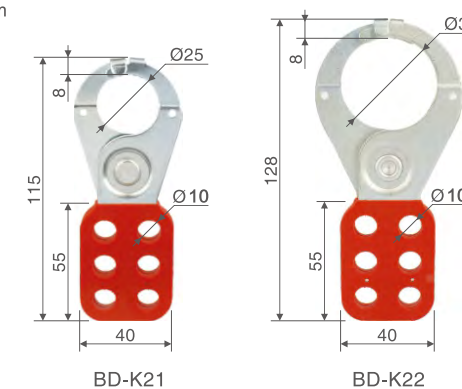

Product Features

- Made of chrome plated or zinc plated steel and nylon PA injection molding or PVC dipping handle.
- The ring hook is designed to prevent being pried off.

Product Selection

Model	Lock hole Dia.	Lock shackle Dia.	Description
BD-K21	10.5mm(2/5")	25mm(1")	Can be accommodated with 6 padlocks(maximum)
BD-K22	10.5mm(2/5")	38mm (1.5")	

BD-K23/K24
ECONOMIC STEEL HASP WITH HOOK

Unit: mm

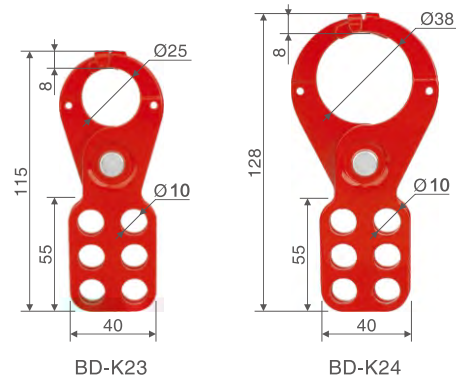

Product Features

- Made of high temperature plastic sprayed steel.
- The ring hook is designed to prevent being pried off.

Product Selection

Model	Lock hole Dia.	Lock shackle Dia.	Description
BD-K23	10.5mm(2/5")	25mm(1")	Can be accommodated with 6 padlocks(maximum)
BD-K24	10.5mm(2/5")	38mm (1.5")	

BD-K31/K31S-1/K31S-2
BUTTERFLY LOCKOUT HASP

Unit: mm

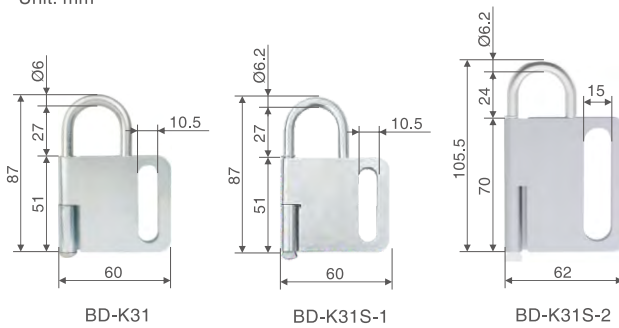

Product Features

- K31 is made of steel and its surface is rust proof and galvanized.
- K31S-1/K31S-2 is made of 304 stainless steel.
- Sturdy and durable.

Product Selection

Model	Shackle Dia.	Shackle inner height	Description
BD-K31	6mm	27mm	Can be accommodated with 6 padlocks(maximum)
BD-K31S-1	6mm	27mm	
BD-K31S-2	6.2mm	24mm	Can be accommodated with 8 padlocks(maximum)

BD-K32/K32S
BUTTERFLY LOCKOUT HASP

Unit: mm

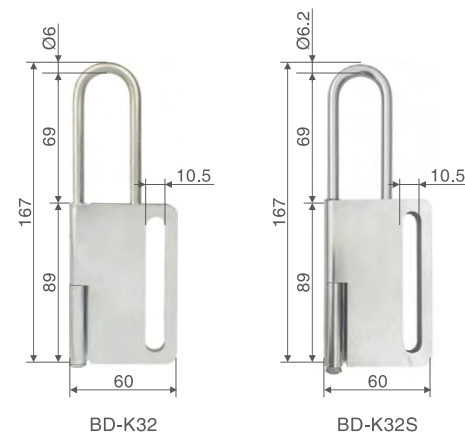

Product Features

- K32 is made of steel and its surface is rust proof and galvanized.
- K32S is made of 304 stainless steel.
- Sturdy and durable.

Product Selection

Model	Shackle Dia.	Shackle inner height	Description
BD-K32	6mm	69mm	Can be accommodated with 10 padlocks(maximum)
BD-K32S	6.2mm	69mm	

BD-K33/K33X
STAINLESS STEEL BUTTERFLY LOCKOUT HASP

Unit: mm

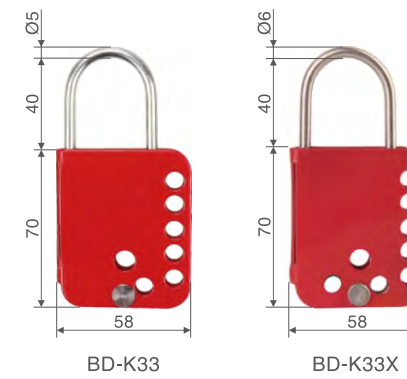

Product Features

- Made of high temperature plastic sprayed 304 stainless steel.
- Sturdy and durable.

Product Selection

Model	Shackle Dia.	Shackle inner height	Description
BD-K32	5mm	40mm	Can be accommodated with 7 padlocks(maximum)
BD-K32S	6mm	40mm	Can be accommodated with 8 padlocks(maximum)

BD-K34
BUTTERFLY LOCKOUT HASP

Unit: mm



Product Features

- Made of ABS and 304 stainless steel.

Product Selection

Model	Shackle Dia.	Shackle inner height	Description
BD-K34	4mm	27mm	Can be accommodated with 2 padlocks(maximum)

BD-K35S
STAINLESS STEEL BUTTERFLY LOCKOUT HASP

Unit: mm

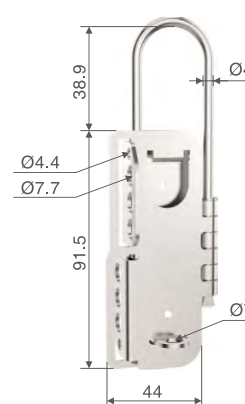

Product Features

- Made of 314 stainless steel.
- Sturdy and durable.

Product Selection

Model	Shackle Dia.	Shackle inner height	Description
BD-K35S	4mm	38mm	Can be accommodated with 10 padlocks(maximum)

BD-K41/K42
NYLON LOCKOUT HASP

Unit: mm

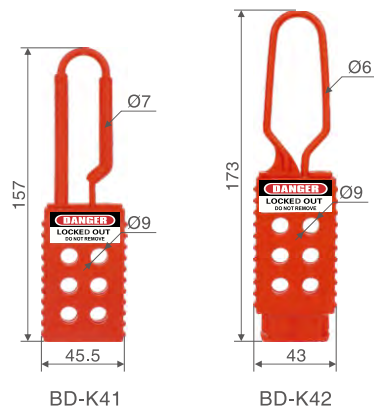

Product Features

- Made from modified PP.
- Apply to places where need electric power isolation and lock and has high requires about corrosive and explosion-proof.
- Opening: push up and down.

Product Selection

Model	Shackle Dia.	Description
BD-K41	7mm	Can be accommodated with 6 padlocks(maximum)
BD-K42	6mm	

BD-K43/K44
NYLON LOCKOUT HASP

Unit: mm

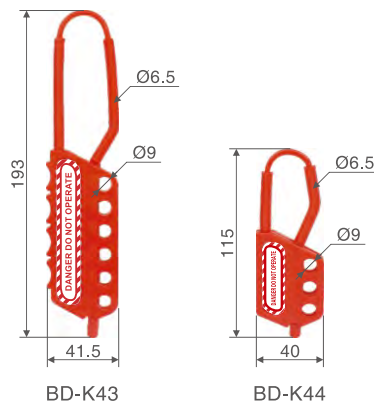

Product Features

- Made from modified PP.
- Apply to places where need electric power isolation and lock and has high requires about corrosive and explosion-proof.
- Side opening.

Product Selection

Model	Shackle Dia.	Description
BD-K43	6.5mm	Can be accommodated with 6 padlocks(maximum)
BD-K44	6.5mm	Can be accommodated with 3 padlocks(maximum)

BD-K45/K46
NYLON LOCKOUT HASP

Unit: mm



Product Features

- The lock beam is made of American Dupont, and the lock body is made of alloy engineering plastic.
- Apply to places where need electric power isolation and lock and has high requires about corrosive and explosion-proof.

Product Selection

Model	Shackle Dia.	Description
BD-K45	3mm	Can be accommodated with 4 padlocks(maximum)
BD-K46	6mm	

BD-K51/K51S
LOCKOUT HASP

Unit: mm

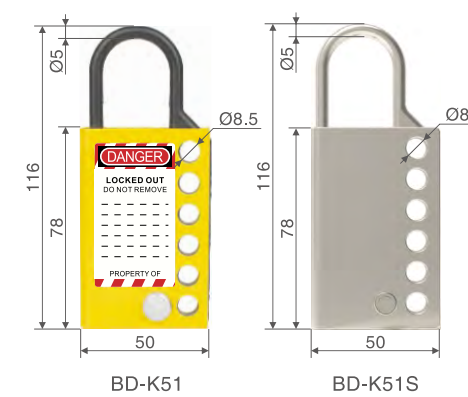

Product Features

- K51 Body is made of steel, hasp beam is made of aluminum.
- K51S Made of 304 stainless steel.
- strong and durable.

Product Selection

Model	Shackle Dia.	Description
BD-K51	5mm	Can be accommodated with 6 padlocks(maximum)
BD-K51S	5mm	

BD-K52/K53/K53A
ALUMINUM LOCKOUT HASP

Unit: mm

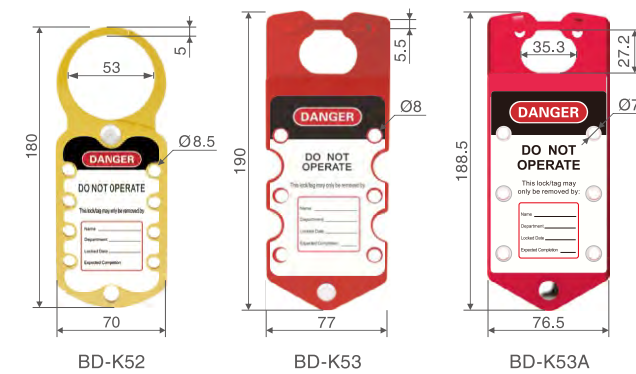

Product Features

- Hasps are made of super strong oxidized aluminum alloy.
- The combination of label and hasp together
- improves the applicability of the product itself, but also makes the heat-resistant design of the tag applicable to a variety of environments
- Labels can be write on with pens.

Product Selection

Model	Description	Color
BD-K52	Can be accommodated with 9 padlocks(maximum)	can be customized
BD-K53	Can be accommodated with 6 padlocks(maximum)	
BD-K53A		

BD-K54
ALUMINUM LOCKOUT HASP



Product Features

- Hasps are made of super strong oxidized aluminum alloy.
- The combination of label and hasp together
- improves the applicability of the product itself, but also makes the heat-resistant design of the tag applicable to a variety of environments
- Labels can be write on with pens.

Product Selection

Model	Description	Color
BD-K54	Can be accommodated with 5 padlocks(maximum)	can be customized

BD-K61 DOUBLE-END ALUMINUM HASP

Unit: mm

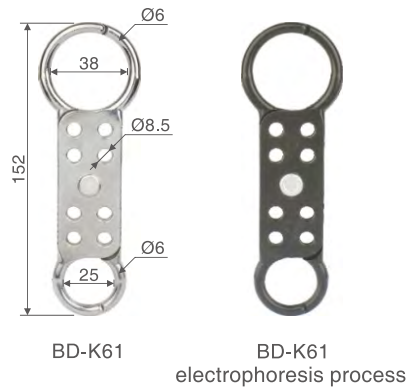

Product Features

- High fire-resisant aluminum alloy.
- Or anti-oxidation treated by high-temperature surge anti rust treatment.
- Double ends are different sizes,two functions.

Product Selection

Model	Shackle Dia.	Description
BD-K61	6mm	Can be accommodated with 8 padlocks(maximum)

BD-K62 DOUBLE-END STEEL HASP

Unit: mm

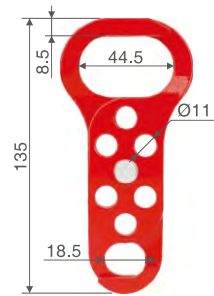

Product Features

- Lock body material: high strength steel.
- Surface: Anti-rust galvanized treatment under-high temperature.
- Hooks in two ends are different, having double functions.

Product Selection

Model	Description
BD-K62	Can be accommodated with 6 padlocks (maximum)

BD-K71/K72/K73 ALUMINUM BUCKLE LOCK

Unit: mm

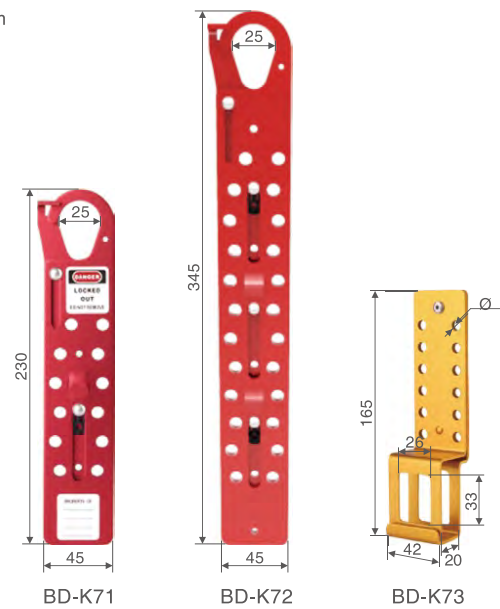

Product Features

- Made from aluminum alloy.
- Lock hole Dia. 7mm or 8mm.
- Suitable for multi-person lock management.

Product Selection

Model	Description
BD-K71	Can be accommodated with 12 padlocks (maximum)
BD-K72	Can be accommodated with 24 padlocks (maximum)
BD-K73	Can be accommodated with 12 padlocks (maximum)



BD-D01~D04
MINIATURE CIRCUIT BREAKER LOCKOUT

Unit: mm

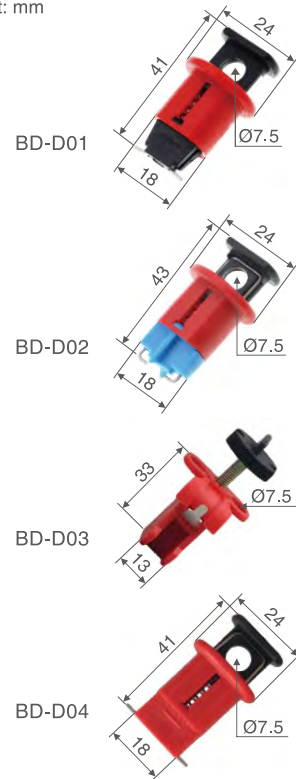

Product Features

- Made from engineering plastic strengthened nylon PA.
- Fit most existing types of European and Asia Circuit Breaker.
- Easily installed with the aid a push button or rotate roller.
- Available for single and multi-pole circuit breaker.
- Recommended to use in combination with a padlock for added safety.
- Can use padlocks with a shackle Dia. up to 7mm.

Product Selection

Model	Description	Application
BD-D01	POS (Pin Out Standard), hole spacing ≤12mm	
BD-D02	PIS (Pin In Standard), hole spacing ≤12mm	
BD-D03	TBLO (Tie Bar Lockout)	
BD-D04	POW (Pin Out Wide), hole spacing ≤20mm	

BD-D05 SERIES
SIMPLE CIRCUIT BREAKER LOCKOUT

Unit: mm

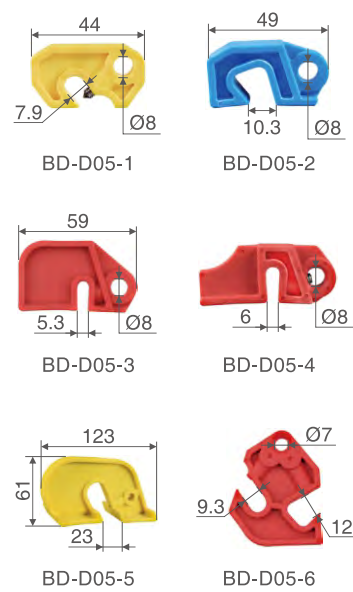

Product Features

- Made from rugged reinforced PA.
- Can lock it with screw driver.
- Can accommodate one safety padlock with shackle Dia.s7mm.
- Can lock all kinds of circuit breakers.

Product Selection

Model	Description	Application
BD-D05-1	Suitable for single pole miniature circuit breakers with handle width ≤7.7mm	
BD-D05-2	Suitable for 2 to 4 poles miniature circuit breakers	
BD-D05-3	Suitable for mini and middle size circuit breakers with handle width ≤5mm	
BD-D05-4	Suitable for mini and middle size circuit breakers with handle width ≤5mm	
BD-D05-5	Suitable for large size circuit breakers	
BD-D05-6	Suitable for mini size circuit breakers with handle width ≤9.3mm middle size circuit breakers with handle width ≤12mm	

BD-D06~D09
SNAP-ON BREAKER LOCKOUT

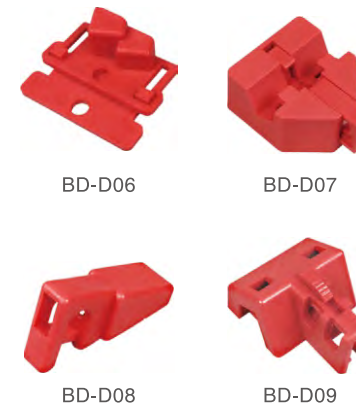

Product Features

- Made from engineering plastic reinforced nylon PA.
- Easy using-snap in right position, it is locked.
- Suitable for seldom miniature circuit breaker with the special handle.(as picture)

Product Selection

Model	BD-D06	BD-D07	BD-D08	BD-D09*
Description	Suitable for very few small electrical appliances with special handles (refer to application scenario diagram)			
Application				

BD-D11~D13
BD-D11X~D13X
CLAMP-ON BREAKER LOCKOUT

Unit: mm



Product Features

- The base seat is made of P A 6 6 + 20 % G F, D 1 1 / D 1 2 / D 1 3 lock body is made of modified PP, D11X/D12X/D13X lock body is made of PA+ABS.
- A wide range of applications, suitable for a variety of medium - sized built-in tripping plastic case circuit breakers.
- Use thumbscrew to clamp lockout securely onto switch tongue, then pull cover and lock in place to prevent clamp from being loosened.
- New blade design provides tighter grip with less torque on thumb screw.
- Detachable cleats expand the range of application breakers.
- The lockouts can take padlocks with a shackle Dia. up to 7mm.
- The base can clamp the bottom of the lock body very easily.
- Long sliding splint ensures locking of the circuit breaker.
- Compared with the old models,the new one is not easy to be broken.

Product Selection

Model	Description	Application
BD-D11	Can lock handle width ≤16.5mm	
BD-D11X		
BD-D12	Can lock handle width ≤41mm	
BD-D12X		
BD-D13	Can lock handle width ≤70mm	
BD-D13X		

BD-D14
MULTI-FUNCTION MINIATURE
BREAKER LOCKOUT

Unit: mm

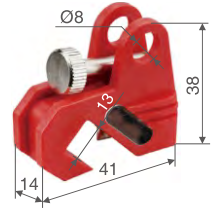

Product Features

- Made of engineering plastic strengthened nylon PA and chrome plated brass screw.
- With locking screws, can be locked without tools.
- Widely used: applicable to all kinds of small and medium sized MCCB, and any miniature circuit breaker.
- Can be customized stainless steel brand.

Product Selection

Model	Description	Application
BD-D14	Suitable for all kinds of small and medium sized moulded case circuit breakers and any mini circuit breakers	

BD-D15/D15W
MULTI-FUNCTION CIRCUIT
BREAKER LOCKOUT

Unit: mm



BD-D15 with pedal BD-D15W without pedal

Product Features

- Made of strong reinforced nylon and chrome plated brass screws;
- With locking screw, no tools can be easily locked;
- Can use the lock beam Dia. ≤ 7 mm safety padlock lock;
- Original U - shaped stainless steel insert, can ensure that there will be no situation after locking swing.

Product Selection

Model	Description	Application
BD-D15	Suitable for medium circuit breaker (handle width ≤ 20 mm) The bottom of the lock body with pedal	
BD-D15W	Suitable for medium circuit breaker (handle width ≤ 20 mm) without pedal at the bottom of the lock body	

BD-D16/D16L
LARGE TYPE CIRCUIT
BREAKER LOCKOUT

Unit: mm

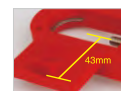
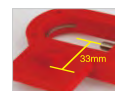
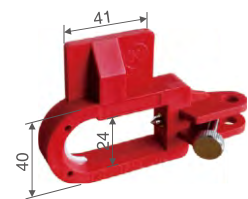

BD-D16 BD-D16L

Product Features

- Made of rugged reinforced nylon and chrome plated brass screws;
- With locking screw, do not need tools to lock, unique U-shaped stainless steel sheet design makes the locking more solid and reliable;
- It can be locked using a padlock with a shackle Dia. of 7mm or less.

Product Selection

Model	Description	Application
BD-D16	Suitable for all kinds of large moulded case circuit breaker (handle thickness ≤ 20 mm), and special push-button circuit breaker	
BD-D16L	Suitable for very few old closed stroke is longer plastic case circuit breaker	

BD-D17/D18
BIDIRECTIONAL MEDIUM
CIRCUIT BREAKER LOCKOUT

Unit: mm

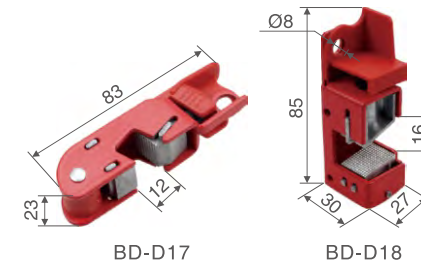

BD-D17

BD-D18

Product Features

- The lock body is made of die-cast aluminum alloy, nylon and steel, and the surface is sprayed treatment.
- With locking screw, no tools can be easily locked.

Product Selection

Model	Description	Application
BD-D17	7.5mm \leq handle width ≤ 12 mm Small and medium circuit breaker	
BD-D18	8mm \leq handle width ≤ 16 mm Small and medium circuit breaker	

BD-D19
DOUBLE-END LOCKS

Unit: mm

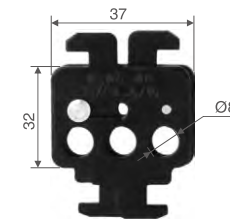

Product Features

- Made from Steel.
- Suitable for Schneider NSX accessory locking equipment Moulded case circuit breakers.
- Several person management and usage.

Product Selection

Model	Description	Application
BD-D19	Suitable for Schneider special circuit breaker	

BD-D20
SMALL-SCALE MINIATURE
CIRCUIT BREAKER LOCKOUT

Unit: mm

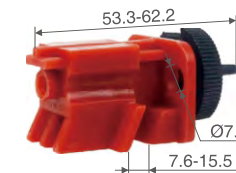

Product Features

- The lock body is made of nylon;
- With locking screw, no tools can be easily locked.

Product Selection

Model	Description	Application
BD-D20	7mm \leq handle width ≤ 15 mm Small circuit breaker	

BD-D21
SNAP-ON BREAKER LOCKOUT

Unit: mm

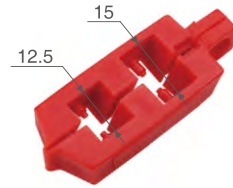

Product Features

- Made of modified engineering plastic nylon PA;
- Simple and convenient to use, just stick in the correct position and lock it;
- Double control design, can be used for different sizes of switch button;
- It can be locked using two security padlocks with the Dia. of the lock beam ≤ 7 mm.

Product Selection

Model	Description	Application
BD-D21	Suitable for very few small circuit breakers with holes on both sides of the handle	

BD-D24/D24W
SELF-LOCKING MEDIUM CIRCUIT BREAKER LOCKOUT

Unit: mm



BD-D24



BD-D24W

Product Features

- Made from rugged reinforced nylon and chrome plated brass screw.
- Comes with locking screw, can lock conveniently by itself without tools.
- Widely used, suitable for handle width ≤ 12 mm, Keyhole Dia. 8.6 mm.

Product Selection

Model	Description	Application
BD-D24	With pedal	
BD-D24W	Without pedal	

BD-D26
SIMPLE CIRCUIT BREAKER LOCKOUT

Unit: mm

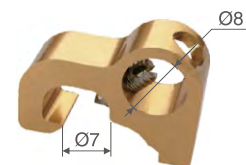

Product Features

- Made of aluminum alloy;
- It should be used with a small flat-head screwdriver.

Product Selection

Model	Description	Application
BD-D26	Suitable for mini circuit breaker	

BD-D27
PIN OUT MINIATURE CIRCUIT BREAKER LOCKOUT

Unit: mm



Product Features

- The lock body is made of stable and wear resistant PBT material;
- Maximum Dia. of locking beam: 8mm;
- Yellow, other colors can be customized.

Product Selection

Model	Description	Application
BD-D27	Suitable for mini circuit breaker	

BD-D28
PIN OUT SCHNEIDER MINIATURE CIRCUIT BREAKER LOCKOUT

Unit: mm

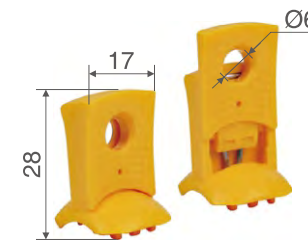

Product Features

- The lock body is made of stable and durable PA66+ ABS material;
- Maximum Dia. of locking beam: 6mm;
- Yellow, other colors can be customized.

Product Selection

Model	Description	Application
BD-D28	Suitable for Schneider special circuit breaker	

BD-D29
MEDIUM CIRCUIT BREAKER LOCKOUT

Unit: mm



Product Features

- Made of strong and durable engineering plastic PC material;
- With locking screw, no tools can be easily locked;
- Maximum handle size: width 75mm x thickness 23mm;
- Allow 3 padlocks with lock shackle ≤ 8 mm.

Product Selection

Model	Description	Application
BD-D29	Mould-case circuit breaker, Minimum size of opening position ≥ 19 mm	

**BD-D100/D110
CIRCUIT BREAKER LOCKOUT**

Unit: mm



Product Features

- The main body is made of engineering PC plastic.
- Keyhole Dia. 8.6mm.
- Suitable for medium and miniature breaker.

Product Selection

Model	Description	Application
BD-D100	A: 46mm abc: 78mm x 29.5mm x 35mm	
BD-D110	A: 50mm abc: 90mm x 29.5mm x 47mm	

**BD-D200
MULTI-FUNCTION
ADJUSTABLE MEDIUM
BREAKER LOCKOUT**

Unit: mm



Product Features

- Made from strong and durable strengthened nylon.
- Keyhole Dia. 7.6mm.
- Suitable for medium and miniature breaker.

Product Selection

Model	Description	Application
BD-D200	handle width ≤ 8 mm Small and medium circuit breaker	

**BD-D301P~D304P
PROTECTIVE COVER FOR
CIRCUIT BREAKER**

Unit: mm



Product Features

- Made of reinforced nylon and transparent high-strengthened glass resin PC.
- Easy to install. just place the protective cover on the circuit breaker, which can be locked and removed at will.
- Can lock 2 safety padlocks with shackle Dia. ≤ 7 mm together.

Product Selection

Model	Description	Application
BD-D301P	适用于各种小型断路器安全上锁	
BD-D302P		
BD-D303P		
BD-D304P		

**BD-D22/D22-2
BREAKER LOCKOUT**

Unit: mm

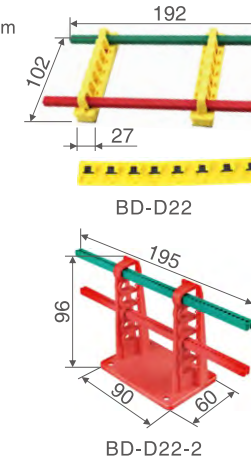

Product Features

- Made of engineering plastic alloy.
- The self-adhesive track on the back can be permanently fixed to the distributor (just clean the surface of the distributor and paste ,no drilling).
- Can be locked by padlock with shackle diameter ≤ 7 mm.
- Red stop rod indicates that the switch is off. Green stop rod indicates that the switch is on.

Product Selection

Model	Description	Application
BD-D22	Lock switches of large and irregular shape (Main rod length 190mm)	
BD-D22-2	Universal knife brake--main rod length is 195mm	

**BD-D23
UNIVERSAL WALL-TYPE
SWITCH COVER**

Unit: mm



Product Features

- Made from engineering plastic ABS and acrylic.
- English warning sign on the body is available.
- Can be locked with safety padlock of shackle Dia. ≤ 7 mm.

Product Selection

Model	Description	Application
BD-D23	Suitable for wall switch, base hole size: 38x40mm	

**BD-D25
POWER HANDLE LOCKOUT**

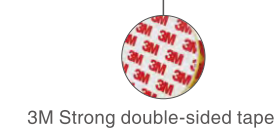

Product Features

- The body is made from ABS.
- Suitable for switch of handle type.
- Can be fixed on electrical board with strong self- adhesive tape.At the same time, it has installing hole and can also be fixed by screw.

Product Selection

Model	Description	Application
BD-D25	8mm \leq Handle width ≤ 16 mm	

BD-D31
ELECTRICAL/PNEUMATIC
PLUG LOCKOUT

Unit: mm

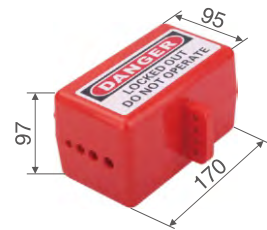

Product Features

- Made from ABS material.
- Double open and quadrilateral lockout design, suitable for all kinds of electrical and pneumatic plug (max Dia. 89mm, max length 127mm) and air hose external screw thread-adaptor.
- The hole in the lockout can lock cable and the bent down pneumatic external screw thread accessory.
- Accommodates 4 pieces padlocks with shackle Dia. less than 7mm to lock it.

Product Selection

Model	Description	Application
BD-D31	5 kinds of pneumatic lock apertures can be locked: 9.5mm, 10.4mm, 11.4mm, 12mm, 18.2mm	

BD-D32
PIN OUTWARD MINIATURE
CIRCUIT BREAKER LOCK

Unit: mm



Product Features

- The lock body is made of reinforced nylon material.
- Lock the circuit breaker in the closed state to prevent false opening.
- Universal Europe, Asia miniature circuit breaker equipment.
- Yellow, other colors to order.

Product Selection

Model	Description	Application
BD-D32	It can be used with a padlock with a lock beam diameter of ≤ 5mm	

BD-D33/D34
INDUSTRIAL PLUG LOCKOUT

Unit: mm

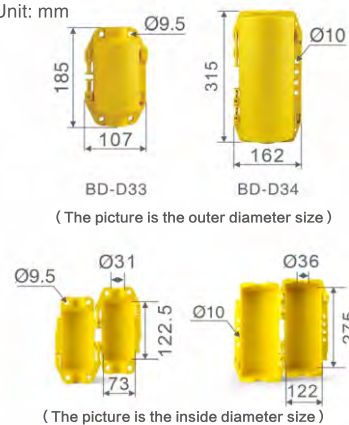

Product Features

- Made from PP.
- Suitable for locking kinds of industrial plugs.
- Allow 4 padlocks to lock at the same time.
- Different colors can be customized.
- Part code Description Application.

Product Selection

Model	Description	Application
BD-D33	Applicable plug range: length ≤120mm, Dia. ≤69mm	
BD-D34	Applicable plug range: length ≤261mm, Dia. ≤114mm	

BD-D41/D42/D43
ELECTRICAL PLUG LOCKOUT

Unit: mm

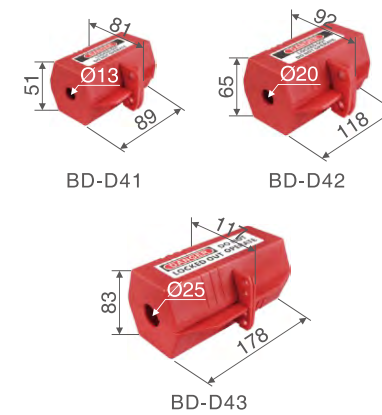

Product Features

- Made from rugged polypropylene.
- Double open and hexagon lockout design, suitable for all kinds of industrial plugs.
- Accommodates 2 to 4 pieces padlocks with shackle Dia. less than 7mm to lock it at the same time.

Product Selection

Model	Description	Application
BD-D41	For cables with a Dia. of 13mm	
BD-D42	For cables with a Dia. of 20mm	
BD-D43	For cables with a Dia. of 25mm	

BD-D41A/D42A
ELECTRICAL PLUG LOCKOUT

Unit: mm

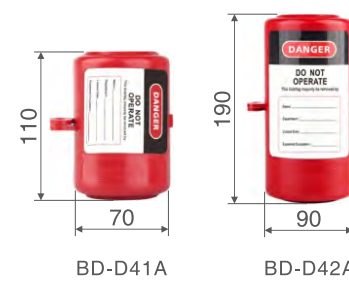

Product Features

- Made of engineering plastic PA+ABS;
- Insulation corrosion resistant, durable, strong, not easy to deformation, impact resistance;
- Double open cylinder lock design, can be used for all kinds of industrial plug safety lock;
- It can be locked with 2 safety padlocks with the Dia. of the lock shackle ≤7mm.

Product Selection

Model	Description	Application
BD-D41A	Inner Dia. 58mm x inner length 95mm x hole Dia. 20mm	
BD-D42A	Inner Dia. 78mm x inner length 170mm x hole Dia. 25mm	

BD-D45
INDUSTRIAL WATERPROOF
SOCKET LOCKOUT

Unit: mm

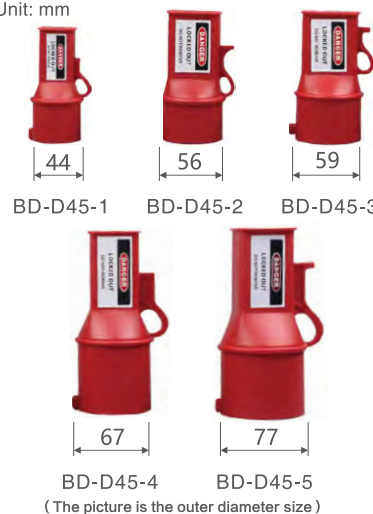

Product Features

- Made from PP material
- With hasp to lock industrial waterproof socket.
- Can accommodate several padlocks to lock it at the same time with hasp.

Product Selection

Model	Description	Application
BD-D45-1	Suitable for small industrial plugs, Lock body hole size: inner diameter 40mm, outer diameter 44mm;	
BD-D45-2	Suitable for small industrial plugs, Lock body hole size: inner diameter 52mm, outer diameter 56mm;	
BD-D45-3	Suitable for medium-sized industrial plugs, Lock body hole size: inner diameter 55mm, outer diameter 59mm;	
BD-D45-4	Suitable for medium-sized industrial plugs, Lock body hole size: inner diameter 63mm, outer diameter 67mm;	
BD-D45-5	Suitable for large industrial plugs, Lock body hole size: inner diameter 73mm, outer diameter 77mm;	

BD-D46
INDUSTRIAL WATERPROOF
PLUG LOCKOUT

Unit: mm

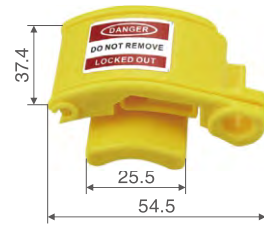

Product Features

- Made from engineering plastic PC material.
- Suitable for locking kinds of industrial waterproof plugs.

Product Selection

Model	Description	Application
BD-D46	Suitable for 16-125A industrial waterproof plug	

BD-D59
SHIP-LINK BUTTON SWITCH
LOCKOUT

Unit: mm



Product Features

- The main body is made of engineering PC plastic, which is waterproof, impact-resistant, insulated and anti-leakage.
- The transparent cover realizes visual management. Easy to lock, easy to use, and prevent misoperation.
- The 3M glue installation method is convenient and efficient.

Product Selection

Model	Description	Application
BD-D59	Suitable for Ship-link button switch lockout size :width*length: 26mm*32mm	

BD-D63/D64
WALL SOCKET LOCKOUT

Unit: mm



BD-D63

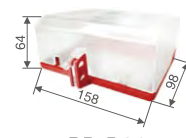

BD-D64

Product Features

- Made from high-strengthened transparent glass resin PC.
- Permanently installed on electrical appliances such as wall switches or transfer switches. Need to open the lock to operate to prevent accidental touch.
- Can fix it by self-tapping screw or 3M double sided glue.

Product Selection

Model	Description	Application
BD-D63	Mounting hole size: 74×74mm	
BD-D64	Mounting hole size: 134×74mm	

BD-D65
CONTROL PANEL LOCKOUT

Unit: mm

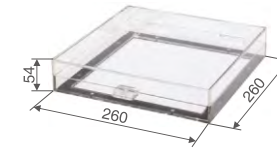

Product Features

- Made from acrylic panel.
- With support rack design, can operate the panel conveniently.
- Can fix it by automatic screw or 3M double-sided tape.
- It is customized product, the base can be coated steel or transparent mask.
- The size of this product can be customized.

Product Selection

Model	Description	Application
BD-D65	Mounting hole size: 220x220mm, inner height 45mm, Can lock kinds of appliance's touch panels	

BD-D66
SWITCH LOCKOUT

Unit: mm

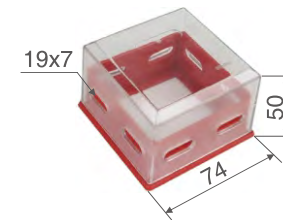

Product Features

- The main cover is made of sturdy and durable engineering PC plastic, and the base is made of PA material, which has good product stability.
- The transparent cover realizes visual management, and the switch status of electrical appliances can be observed directly without unlocking operation, which is convenient to use.
- The four-sided hollow keyhole design can realize the safe management of locking by multiple people, and the locking is convenient and safe.
- The reserved hole design of the base is easy to install, and it can also be installed with 3M adhesive. Various installation and use methods are efficient and convenient.

Product Selection

Model	Description	Application
BD-D66	Bottom of inner box: 51mm x 51mm; Internal height: 48.5mm	

BD-D67
SWITCH LOCKOUT

Unit: mm



Product Features

- The main body is made of engineering PC plastic, which is waterproof, impact-resistant, insulated and anti-leakage.
- The transparent cover realizes visual management. Easy to lock, easy to use, and prevent misoperation.
- The 3M adhesive installation method is convenient and efficient.

Product Selection

Model	Description	Application
BD-D67	Bottom of inner box: 70mm x 70mm	

**BD-D71
LOCKOUT BAG**

Unit: mm



Product Features

- Made of wear-resistant polyester cloth;
- Insert the PVC liner to prevent others from touching the buttons on the lift controller;
- There is enough space to realize to lockout a variety of driving control button and various oversized plugs or parts;
- English warning signs are printed on the surface.

Product Selection

Model	Description	Application
BD-D71	Elasticated pocket for locking	
BD-D71-2		
BD-D71-3		

**BD-D81
ELECTRICAL HOLE LOCKOUT**

Unit: mm

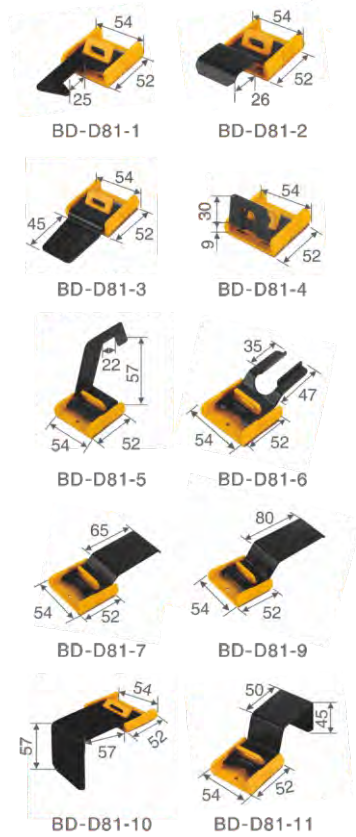

Product Features

- The lock body is made of alloy engineering plastics and A3 steel plate (painted);
- It can realize the locking of various non-standard electrical appliances or power distribution cabinets;
- Fixed by double-sided 3M glue or screws;
- It can install locks of different shapes according to customer requirements;
- Base size: width 54mm x length 52mm, metal plate thickness 2mm.

Product Selection

Model	Description	Application
BD-D81-1	Lock knob switch, change over switch.	
BD-D81-2	Lock button switch, the lock hole of the distribution cabinet	
BD-D81-3	Lock cabinet door, electrical handle hole, low voltage cabinet and so on.	
BD-D81-4	Lock switch handle, change over switch of the drawer cabinet.	
BD-D81-5	Lock knife switch, handle switch and so on.	
BD-D81-6	Lock knob switch, change over switch.	
BD-D81-7	Lock button switch, the lock hole of the distribution cabinet.	
BD-D81-9	Lock doors, electrical handle hole.	
BD-D81-10	Lock button switch, the lock hole of the distribution cabinet.	
BD-D81-11	Lock knife switch, handle switch and so on.	

**BD-D82
ELECTRICAL HOLE LOCKOUT**

Unit: mm

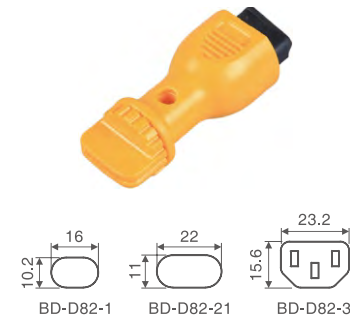

Product Features

- Made from engineering plastic PC, rubber, screw and extrusion sheet.
- Rotate the knob on the lockout, then the rubber is out of shape, it is locked.
- Can custom made kinds of rubber hole stopple to lock non-standard electrical hole and computer's power socket.
- Custom made different specification rubbers stopple according to electrical appliance hole to lock.

Product Selection

Model	Description	Application
BD-D82-1	To lock kinds of non-standard shape, handles holes and so on	
BD-D82-2		
BD-D82-3	To lock kinds of non-standard shape, handles holes and so on, 3 holes	

**BD-D83
PLUG LOCKOUT**

Unit: mm



Product Features

- The lock body is made of engineering alloy plastic ABS +PC;
- Use the built-in lock cylinder to lock directly;
- Suitable for locking American standard plugs.

Product Selection

Model	Description	Application
BD-D83	Use the built-in lock cylinder to lock directly, Suitable for locking American standard plugs	

**BD-D50
EMERGENCY BUTTON
LOCKOUT'S BASE**



Product Features

- Used with emergency stop lockout, such as BD-D53, BD-D55, BD-D56.
- Install on the controller button forever, avoid accidentally touch, easy to use.

Product Selection

Model	Description	Application
BD-D50-1	suitable for button base's Dia.: 16mm to 22mm	
BD-D50-2	suitable for button base's Dia.: 27mm to 32mm	

**BD-D51/D52
EMERGENCY STOP LOCKOUT**

Unit: mm



Product Features

- Made from high strength transparent glass resin PC.
- Install on the controller button forever, avoid accidentally touch.
- Color: transparent, and red.

Product Selection

Model	Description	Application
BD-D51	install hole inner Dia.: 22mm	
BD-D52	install hole inner Dia.: 30mm	

**BD-D51A/D52A
EMERGENCY STOP LOCKOUT**

Unit: mm

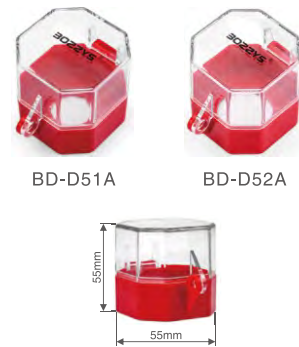

Product Features

- Made from high strength transparent glass resin PC.
- Install on the controller button forever, avoid accidentally touch.
- Color: transparent, and red.

Product Selection

Model	Description	Application
BD-D51A	install hole inner Dia.: 22mm	
BD-D52A	install hole inner Dia.: 30mm	

**BD-D53/D55/D56
EMERGENCY STOP LOCKOUT**

Unit: mm

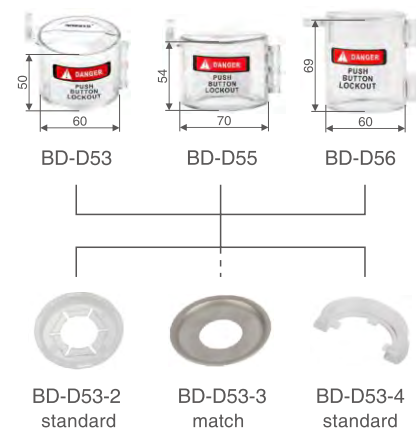

Product Features

- Made from high-strengthened transparent glass resin PC.
- Avoid dismantling, easy to install, install the base on the bottom of the emergency stop switch, can lock and remove at random.
- Install on the push or spiral release emergency stop button, avoid accidentally touch.
- When no need to lock at ordinary time, leave the base at site, will not affect the operation at all. Put the cover to lock the base when necessary

Product Selection

Model	Description	Application
BD-D53	Inner Dia. 55mm x inner height 43mm, hole Dia. 46mm	
BD-D55	Inner Dia. 65mm x inner height 49mm, hole Dia. 46mm	
BD-D56	Inner Dia. 54.5mm x inner height 64mm, hole Dia. 45.5mm	
BD-D53-2	Suitable for inner Dia. 22/30mm hole button base	
BD-D53-3	Suitable for inner Dia. 22mm open hole stainless steel base	
BD-D53-4	Suitable for inner Dia. 30/38mm hole button base	

**BD-D54
EMERGENCY STOP LOCKOUT**

Unit: mm



Product Features

- Made from high-strengthened transparent glass resin PC.
- Install on the wall switch or change-over switch and other electrical appliances permanently, open it then operate, avoid accidentally touch.

Product Selection

Model	Description	Application
BD-D51A	Dia. of installing hole: 20mm or 30mm	

**BD-D57/D58
EMERGENCY STOP LOCKOUT**

Unit: mm

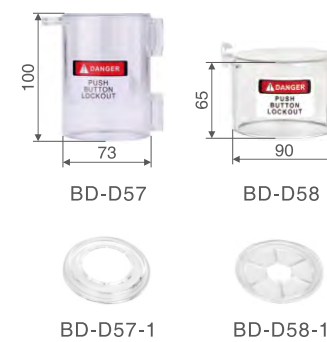

Product Features

- Made from high-strengthened transparent glass resin PC.
- Avoid dismantling, easy to install, install the base on the bottom of the emergency stop switch, can lock and remove at random.
- Install on the push or spiral release emergency stop button, avoid accidentally touch.
- When no need to lock at ordinary time, leave the base at site, will not affect the operation at all. Put the cover to lock the base when necessary.

Product Selection

Model	Description	Application
BD-D57	hole's diameter: 57mm; wall thickness: 3mm	
BD-D57-1	Suitable for hole button bases with an inner diameter of 34-39mm	
BD-D58	hole's diameter: 80mm; wall thickness: 3mm	
BD-D58-2	Suitable for hole button bases with an inner diameter of 24-62mm	

**BD-D60
EMERGENCY STOP LOCKOUT**

Unit: mm

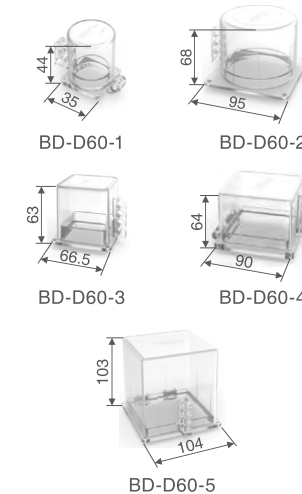

Product Features

- Transparent high-strengthened glass resin PC material.
- No need disassemble, easy to install, just install the base on the bottom of the emergency stop switch. it can be locked and removed at will.
- Permanently installed on the emergency stop button which can push-pull or screw release to prevent accidental touch.
- According to the reserved holes of the lock, it can be locked with 2-4 safety padlocks with the Dia. of the lock beam ≤ 7mm can be locked

Product Selection

Model	Dimensions inside the base	Inner height of the base
BD-D60-1	Dia. 27.5mm	42mm
BD-D60-2	Dia. 75mm	65.5mm
BD-D60-3	50 x 50mm	60mm
BD-D60-4	70 x 70mm	61.5mm
BD-D60-5	84 x 84mm	100.5mm

BD-D67A
EMERGENCY STOP LOCKOUT

Unit: mm

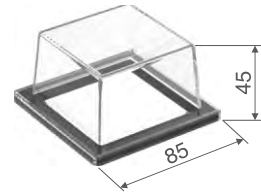

Product Features

- Made of engineering plastic PC, it is waterproof, impact-resistant, insulated and leak-proof;
- Visual management of the protective cover, easy to lock, easy to use, prevent misoperation;
- Rubber magnetic installation method, magnetic locking, can be locked or removed at any time.

Product Selection

Model	Description
BD-D67A	Inner dimensions: bottom 58x58mm, height 42.7mm

BD-D69
ROTATABLE BUTTON COVER

Unit: mm

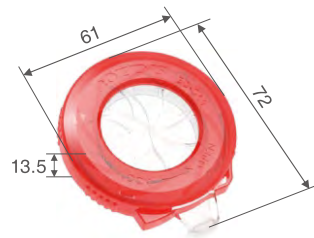

Product Features

- Made from engineering plastic PC;
- 16mm/23mm/30mm three hole pitch size mounting base;
- It is suitable for most push button switches on the market, and the base comes with 3M glue. It can be concealedly installed on the equipment control panel, and the installation is completed by snapping the lock, which is convenient and quick;
- When in use, the ON/OFF status of the emergency stop button can be checked through the fully transparent opening and closing sheet.

Product Selection

Model	Description	Application
BD-D69	Dia. of installing hole: 16mm or 23mm or 30mm	

BD-D701~D704
FLAT PUSH BUTTON
PROTECTIVE COVER

Unit: mm

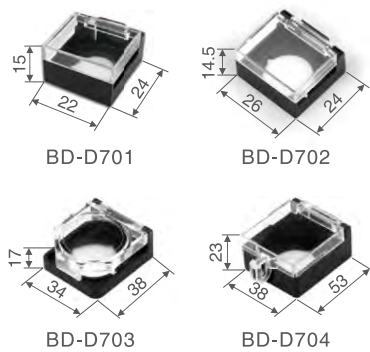

Product Features

- Made of engineering plastic ABS and transparent high-strength glass resin PC.
- The transparent cover realizes visual management and protect the buttons from accidental touch during work and production.
- Widely used and easy to install.

Product Selection

Model	Dimensions inside	Dia. of installing hole
BD-D701	Length 20mm x width 18mm x height 12mm	16mm
BD-D702	Length 24mm x width 18mm x height 12mm	16mm
BD-D703	Length 30mm x width 30mm x height 13mm	22mm
BD-D704	Length 34mm x width 36mm x height 20mm	22mm

BD-D711/D712
TRANSPARENT FLAT BUTTON
PROTECTIVE COVER

Unit: mm

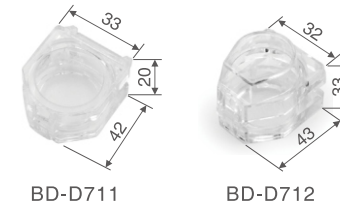

Product Features

- Made of high-strengthened glass resin PC.
- The transparent cover realizes visual management and protect the buttons from accidental touch during work and production.
- Widely used and easy to install.

Product Selection

Model	Description	Dimensions inside	Dia. of installing hole
BD-D701	Suitable for flat buttons	Length 30mm x width 30mm x height 16mm	22mm
BD-D702	Suitable for knobs	Length 30mm x width 32mm x height 25mm	

BD-D721~D723
TRANSPARENT PUSH BUTTON
PROTECTIVE COVER

Unit: mm

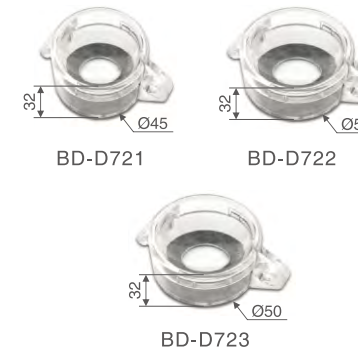

Product Features

- Made of high-strengthened glass resin PC.
- The transparent cover realizes visual management and protect the buttons from accidental touch during work and production.
- Widely used and easy to install.
- Only can lock 1 safety padlock with shackle Dia. ≤7mm.

Product Selection

Model	Dimensions inside	Dia. of installing hole
BD-D721	Dia. 40mm x height 28mm	16mm
BD-D722	Dia. 45mm x height 27mm	22mm
BD-D723	Dia. 45mm x height 27mm	25mm

BD-D731~D734
YELLOW BASE PUSH BUTTON
SWITCH PROTECTIVE COVER

Unit: mm

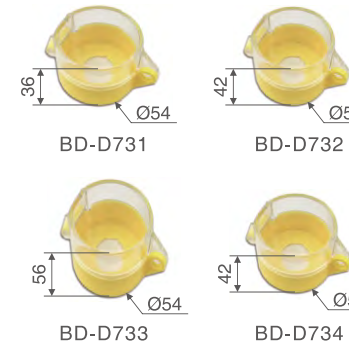

Product Features

- Made of engineering plastic ABS and transparent high-strength glass resin PC.
- The transparent cover realizes visual management and protect the buttons from accidental touch during work and production.
- Widely used and easy to install.
- Only can lock 1 safety padlock with shackle Dia. ≤7mm.

Product Selection

Model	Dimensions inside	Dia. of installing hole
BD-D731	Dia. 49mm x height 32mm	22mm
BD-D732	Dia. 49mm x height 37mm	
BD-D733	Dia. 49mm x height 51mm	
BD-D734	Dia. 49mm x height 37mm	25mm

BD-D741~D748
YELLOW PUSH BUTTON
WITCH PROTECTIVE COVER



Product Features

- Made of strong and durable reinforced nylon.
- Easy and quick to install to warn operations effectively.
- Prevent misoperation, safety production first.

Product Selection

Model	外尺寸	Dimensions inside	Dia. of installing hole
BD-D741	Dia. 31mm × height 20mm	Dia. 24mm × height 18mm	16mm
BD-D742	Dia. 44mm × height 20mm	Dia. 24mm × height 18mm	
BD-D742P	Dia. 52mm × height 23mm	Dia. 31mm × height 21mm	
BD-D743	Dia. 47mm × height 27mm	Dia. 41mm × height 42mm	
BD-D744	Dia. 68mm × height 30mm	Dia. 62mm × height 28mm	25mm
BD-D745	Length 69mm × width 59mm × height 32mm	Length 60mm × width 57mm × height 27mm	
BD-D746	Length 71mm × width 65mm × height 48mm	Length 65mm × width 66mm × height 43mm	
BD-D747	Dia. 60mm × height 29mm	Dia. 54mm × height 26mm	
BD-D747S	Dia. 48mm × height 29mm	Dia. 48mm × height 29mm	
BD-D738	Length 48mm × width 55mm × height 40mm	Length 48mm × width 55mm × height 40mm	

BD-D749/D750
EMERGENCY STOP PUSH
BUTTON PROTECTIVE COVER

Unit: mm

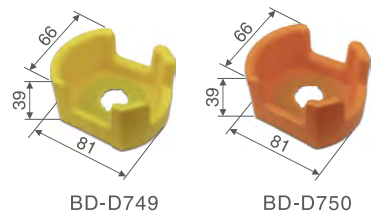

Product Features

- Made of strong and durable reinforced nylon.
- Easy and quick to install to warn operations effectively.
- The installation method with back glue which is convenient and efficient.

Product Selection

Model	Dimensions inside	Dia. of installing hole
BD-D749	Length 50mm × width 67mm × height 35mm	22mm
BD-D750	Length 50mm × width 67mm × height 35mm	25mm

BD-D751~D754
YELLOW EMERGENCY STOP
SWITCH WARN SIGN



Product Features

- Made of strong and durable reinforced nylon.
- Easy and quick to install to warn operations effectively.

Product Selection

Model	Dia.	Dia. of installing hole
BD-D751	46mm	22mm
BD-D752	39mm	
BD-D753	60mm	25mm
BD-D754	66mm	

BD-D761~D763
BUTTON BOX DUST PLUG



Product Features

- The main body is made from engineering plastic PC.
- Flame-retardant and fire-resistant shell, cold and high temperature resistance, waterproof, impact, resistance, insulation and leakage prevention.

Product Selection

Model	Description
BD-D761	Suitable for push button max Dia. 16mm
BD-D762	Suitable for push button max Dia. 22mm
BD-D763	Suitable for push button max Dia. 30mm

BD-D771/D772
BUTTON WARNING SIGN



Product Features

- The main body is made from engineering plastic PC.
- Flame-retardant and fire-resistant shell, cold and high temperature resistant, impact resistant.

Product Selection

Model	Description
BD-D771	Length 30mm × width 46mm
BD-D772	Length 30mm × width 46mm

BD-D781/D782
BUTTON MOUNTING WRENCH

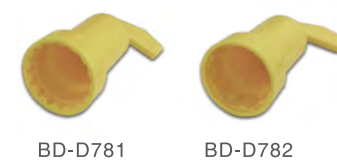

Product Features

- The main body is made from engineering plastic PC.
- It can improve installation efficiency and reduce labor intensity of installation workers.

Product Selection

Model	Description
BD-D781	Dia. of installation: 22mm
BD-D782	Dia. of installation: 22mm

VALVE LOCKOUT



BD-F01/F01D/F02 ADJUSTABLE BALL VALVE LOCKOUT

Unit: mm

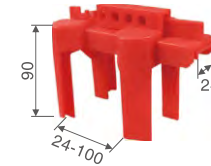

BD-F01

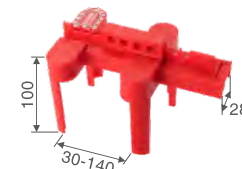

BD-F01D

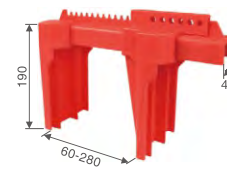

BD-F02

BD-F03/F03N/F04 STANDARD BALL VALVE LOCKOUT

Unit: mm

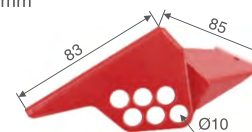

BD-F03



BD-F03N

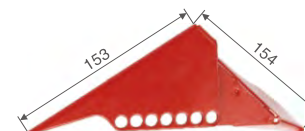

BD-F04-1

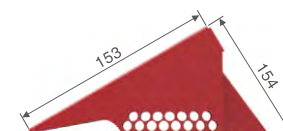

BD-F04-2

Product Features

- Made of polypropylene PP.
- It can be locked with a safety padlock with a Dia. of the lock beam \leq 9mm.
- Color red, other colors to order.

Product Selection

Model	Description	Application
BD-F01	suitable for DN8-DN50 valve	
BD-F01D	suitable for DN50-DN100 valve	
BD-F02	suitable for DN50-DN200 valve	

Product Features

- BD-F03 and BD-F04 are made of steel plate, the surface is sprayed with high temperature, not easy to rust; BD-F03N is made of polypropylene PP material;
- Dedicated to quarter-turn ball valves in locked closed state;
- Color red, other colors to order. Chinese and English warning labels are available.

Product Selection

Model	Description	Application
BD-F03	suitable for DN8-DN50 valve	
BD-F03N		
BD-F04-1	suitable for DN50-DN200 valve	
BD-F04-2		

BD-F05/F06/F07
ADJUSTABLE BALL VALVE LOCKOUT

Unit: mm

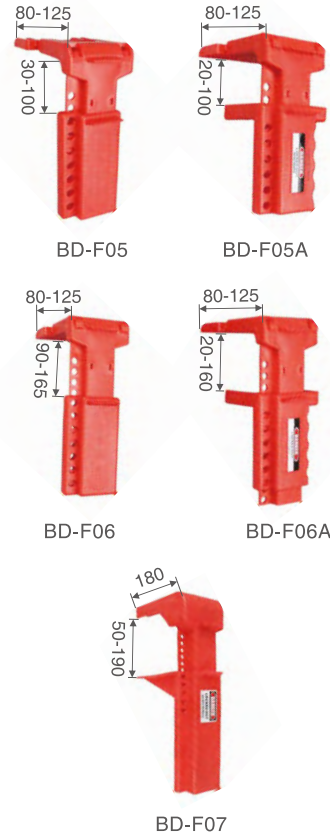

Product Features

- Made of high temperature resistant, high strength polypropylene PP.
- Lock out double roll valves.
- With auxiliary rear gear parts, locked heightening extended ball valve.

Product Selection

Model	Description	Application
BD-F05	suitable for DN8-DN50 valve	
BD-F05A	suitable for DN8-DN50 valve, with auxiliary rear gear parts	
BD-F06	suitable for DN50-DN70 valve	
BD-F06A	suitable for DN50-DN70 valve, with auxiliary rear gear parts	
BD-F07	suitable for DN70-DN200 valve	

BD-F08/F08P
ADJUSTABLE FLANGED BALL VALVE LOCKOUT

Unit: mm

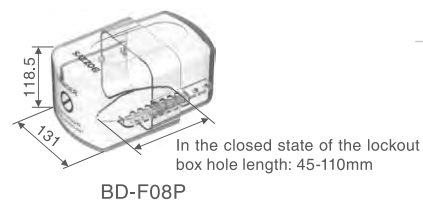
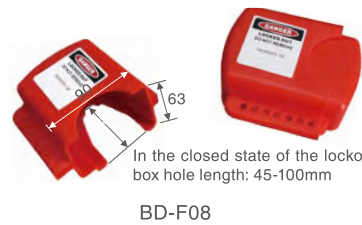

Product Features

- Made of polypropylene PP;
- It can be locked with a safety padlock with a Dia. of the lock beam \leq 9mm;
- F08 color red, F08P transparent color, other colors need to be ordered.

Product Selection

Model	Description	Application
BD-F08	suitable for DN8-DN125 valve	
BD-F08P	suitable for DN15-DN200 valve	

BD-F09/F09X
ADJUSTABLE BALL VALVE LOCKOUT

Unit: mm

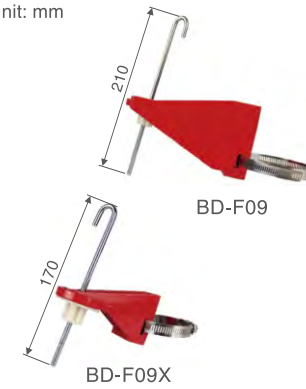

Product Features

- Made from zinc alloy, surface treatment by high temperature spray plastic, not easy to rust.
- Used to lock industrial ball valve.
- Maximum padlock Dia.: 7mm.
- Color: red, other colors need to be customized.
- Suitable for all ball valves with a thickness of \leq 10mm.

Product Selection

Model	Description	Application
BD-F09	Size: 163x56x186mm, suitable for handle length \leq 150mm	
BD-F09X	Size: 108x49.5x155mm, suitable for handle length \leq 150mm	

BD-F10
FLANGE BALL VALVE LOCKOUT BAG

Unit: mm



Product Features

- The bag body is made of PC wear-resistant material, which is durable in harsh environment.
- The fixed belt is made of PP, which makes the lock bag more stable and effective.
- 3pcs safety padlocks(Dia. \leq 7mm) can lock on at the same time.
- The lock bag comes with a handle storage bag to store the matching locks, which is convenient and efficient to use, can prevents the locks from being lost.

Product Selection

Model	Description	Application
BD-F10	Valve head Dia \leq 30mm	

BD-F11(T)~F15(T)
STANDARD BALL VALVE LOCKOUT

Unit: mm



Product Features

- BD-F11~F15 are made of ABS, BD-F11T~F15T are made of PC;
- Dedicated to locking gate valves with a stem Dia. (handwheel Dia.) of 25mm-330mm;
- It can be locked with a safety padlock with a Dia. of the lock beam \leq 7mm;
- Color red or clear, other colors to order. Chinese and English warning labels are available.

Product Selection

Model	Valve rod Dia. (Wheel dia)	Hole dia	Inner Height	Application
BD-F11/F11T	25-64mm(1"-2.5")	19mm	28mm	
BD-F12/F12T	64-127mm(2.5"-5")	44mm	35mm	
BD-F13/F13T	127-165mm(5"-6.5")	62mm	40mm	
BD-F14/F14T	165-254mm(6.5"-10")	88mm	60mm	
BD-F15/F15T	254-330mm(10"-13")	105mm	60mm	

BD-F11A~F15A
STANDARD BALL VALVE LOCKOUT

Unit: mm



Product Features

- Made from imported DuPont engineering plastics.
- The different size semicircle design, two parts can be combined into one when storing and carrying, reduce a half volume.
- Locked by 2-4 pcs padlocks, locked shackle Dia. ≤7mm.
- Color: red, other colors need to be customized. Label can be customized.

Product Selection

Model	Valve rod Dia. (Wheel dia)	Hole dia	Inner Height	Application
BD-F11A	25-64mm(1"-2.5")	19mm	30mm	
BD-F12A	64-127mm(2.5"-5")	44mm	35mm	
BD-F13A	127-165mm(5"-6.5")	62mm	55mm	
BD-F14A	165-254mm(6.5"-10")	90mm	60mm	
BD-F15A	254-330mm(10"-13")	105mm	65mm	
BD-F15Plus	330-450mm(13"-18")	125mm	60mm	
BD-F15B	450-600mm(18"-24")	125mm	65mm	

BD-F16
ADJUSTABLE VALVE LOCKOUT

Unit: mm



Product Features

- Made from polypropylene PP.
- Lock range can be adjusted. Lock the hand wheel Dia. 25mm-165mm(1"-6.5")valve.
- Locked by padlock . padlock's shackle Dia. max 7mm.
- Color: red, other colors need to be customized. Tagout is available.

Product Selection

Model	Valve rod Dia. (Wheel dia)	Application
BD-F16	25-165mm(1"-6.5")	

BD-F20
ADJUSTABLE BUTTERFLY VALVE LOCKOUT

Unit: mm

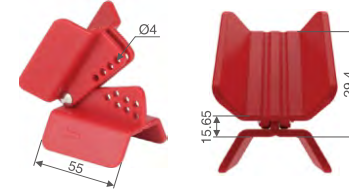

Product Features

- Made from Nylon PA +ABS.
- Suitable for butterfly valve.
- Use with 4mm Dia. cable lockout.

Product Selection

Model	Description	Application
BD-F20	Adjustable angle: 15° - 36°	

BD-F21
BUTTERFLY VALVE LOCKOUT

Unit: mm

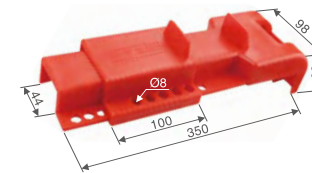

Product Features

- Made from polypropylene PP.
- Locked by padlock, locked shackle Dia. max 7mm.
- Color: Red, other colors can customized.

Product Selection

Model	Description	Application
BD-F21	Suitable for butterfly valves with handle width: 8mm-42mm	

BD-F22
BUTTERFLY VALVE LOCKOUT

Unit: mm

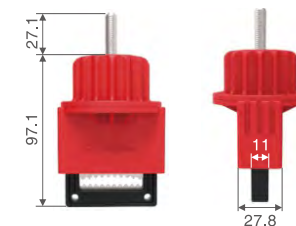

Product Features

- Made from polypropylene PP.
- Suitable for some butterfly valve.
- Color: Red, other colors can customized.

Product Selection

Model	Description	Application
BD-F22	Valve rod Dia.: width≤42mm, Max opening ≥14.5mm; height: 5mm-35mm	

BD-F31(X)~F35(X)
UNIVERSAL VALVE LOCKOUT

Unit: mm



Product Features

- Made from engineering plastic strengthened nylon PA and stainless steel.
- Fit the new open-ended clamp over the closed ring, used to lock out the large handle,
- Also can used to Large leverage ,T-shape handles and other hard-to-secure mechanical devices.
- Cable accessories can be used 3.2mm (1/8 ") PVC stainless steel metal cable coated by PVC.
- Suitable for gate valve, ball valve, butterfly valve and so on.

Product Size

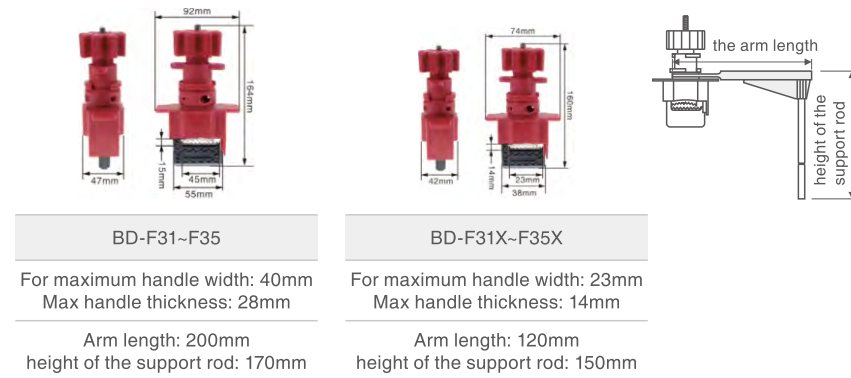

Product Selection

Model	Description	Application
BD-F31/F31X	Single Arm Universal valve Lockout/ Small Single Arm Universal valve Lockout	
BD-F32/F32X	Double Arm Universal valve Lockout/ Small double Arm Universal valve Lockout	
BD-F33/F33X	Universal Valve lockout/ Small Universal Valve lockout	
BD-F34/F34X	Universal Butterfly Valve lockout/ Small Universal Butterfly Valve lockout	
BD-F35/F35X	Universal Valve lockout/ Small Universal Valve lockout	

BD-F36
MULTI-FUNCTION VALVE LOCKOUT

Unit: mm

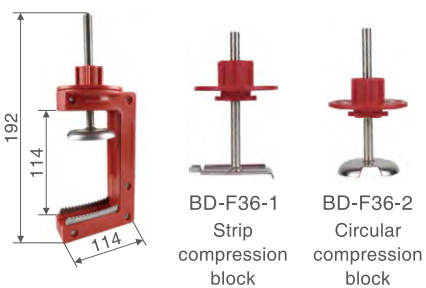

Product Features

- The lock body is made of engineering plastic PC. Toothed carbon steel sheet and stainless steel screws.
- With self-contained tightening screw, easy to lock by yourself without tools.
- 192mm (height) *94mm (width) *32mm (thickness) (Not include Screw rod length)
- Applicable locking range: 31mm-100mm.
- Maximum padlock Dia.: 7mm.

Product Selection

Model	Valve rod Dia. (Wheel dia)	Application
BD-F36-1	For Butterfly Valve	
BD-F36-2	For Valve	

BD-F37
PULL-HANDLE BUTTERFLY VALVE LOCKOUT

Unit: mm

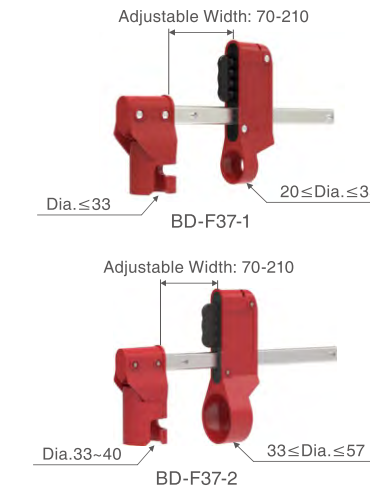

Product Features

- Made from Alloy aluminum and engineering plastic.
- 4 padlocks can be locked at the same time.

Product Selection

Model	Description	Application
BD-F37-1	valve rod diameter $\leq 33\text{mm}$, $20\text{mm} \leq$ valve handle diameter $\leq 35\text{mm}$	
BD-F37-2	Between 33 and 40 diameters $33\text{mm} \leq$ valve handle diameter $\leq 57\text{mm}$	

BD-F41~44
PLUG VALVE LOCKOUT

Unit: mm



Product Features

- The lock is made of engineering plastic PP
- and stainless steel locking braid.
- Suitable for manual plug valves with a Dia. of 1"-8".
- Effectively applicable to such difficult-to-lock valves.
- Durable and vandal-proof. Compact size and easy to use.

Attention

Select the right size
Select the right plug lockout by measuring the size of A and B (Stem Dia.)

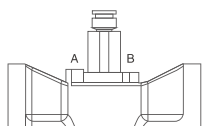

If the operating wrench and the valve stem plane above the clamp can still be completely engaged, the base and clamp of the plug valve lockout can be leave on the valve for standby . At this time, just remove the plug valve cover and padlock to open the valve.

Product Selection

Model	Valve stem Dia. (hand wheel Dia.)	Application
BD-F41	$\leq 22\text{mm}$	
BD-F42	23-34mm	
BD-F43	44-52mm	
BD-F44	55-62mm	

BD-FL01/02/03 BLIND FLANGED LOCKOUT DEVICE

Unit: mm

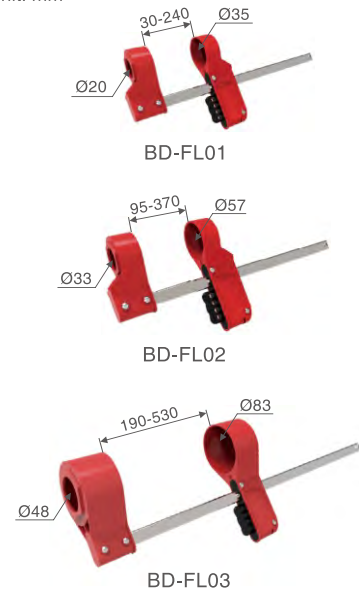

Product Features

- Made from Alloy aluminum and engineering plastic .
- 4 padlocks can be locked at the same time.
- Durable powder spraying aluminum clamp+hardened steel sliding strip, ensuring usage no worries.

Product Selection

Model	Description	Application
BD-FL01	Suitable for flange blind plate width between 30-240mm	
BD-FL02	Suitable for flange blind plate width between 95-370mm	
BD-FL03	Suitable for flange blind plate width between 190-530mm	

BD-D72/D73 MAN HOLE LOCKOUT BAG

Unit: mm



Product Features

- Made from wear resisting polyester cloth.
- With 5 meters cable lockout, It can be locked In many ways .
- Print warning sign on surface.

Product Selection

Model	Description	Application
BD-D72	Cable lockout need buy separately	
BD-D73-1	Ventilated hood with elastic confined space	
BD-D73-2	Locked in ventilated hood confined space	
BD-D73-3		

PNEUMATIC LOCKOUT



BD-Q01
PNEUMATIC QUICK-DISCONNECT LOCKOUT

Unit: mm

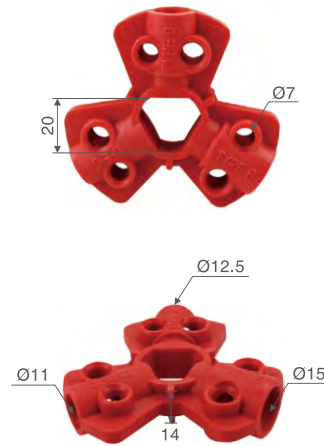

Product Features

- Made from impact resistant engineering plastic nylon PA.
- No need to install and straight interlock valve, can be isolated pneumatic power, lower cost, more convenient.
- Locks can be connected with external threaded joints to isolate equipment from all compressed air sources.
- Hole in the center of device allows for permanent storage on an air hose and a loop on the side can be used to hang the hose and lockout device.
- Can be equipped with padlocks, lock shackle Dia. of 6.4mm(1/4") or 7.1mm (9/32").

Product Selection

Model	Description	Application
BD-Q01	Fitted with 6.4mm, 9.5mm, 12.7mm screwed joint	

BD-Q21(T)~Q24(T)
CYLINDER TANK LOCKOUT

Unit: mm



BD-Q21~Q24



BD-Q21T~Q24T

Product Features

- Made from engineering plastic ABS. (Adding "T" after the product part code means transparent, it is made of PC material)
- Used to lock out the tank, including the propane tanks on forklifts trucks and stand alone propane tanks.
- Easy to avoid unauthorized operation of the valve stem.

Product Selection

Model	Description	Application
BD-Q21/Q21T	Suitable for hole Dia. less than 30mm, inner Dia. 80mm, inner height 35.5mm	
BD-Q22/Q22T	Suitable for hole Dia. less than 40mm, inner Dia. 100mm, inner height 40mm	
BD-Q23/Q23T	Suitable for hole Dia. less than 24.5mm, inner Dia. 60mm, inner height 30mm	
BD-Q24/Q24T	Suitable for hole Dia. less than 40mm, inner Dia. 60mm, inner height 45mm	

BD-Q11
AIR SOURCE LOCKOUT

Unit: mm

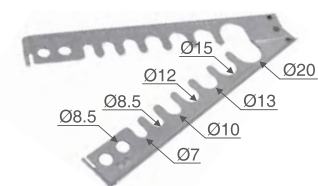

Product Features

- Made from 304 stainless steel.
- Applied to the fitting and prevents it from being reconnected to the pressurized air source.
- 2 padlocks can be locked with ≤7mm shackle Dia.
- Size: Width 35mm x Length 196mm x Thickness 3mm
- Used together with safety padlocks and safety hasps.

Product Selection

Model	Description	Application
BD-Q11	Suitable for air supply joints with a Dia. of 7mm - 20mm	

BD-Q31
CYLINDER TANK LOCKOUT

Unit: mm



Product Features

- Made from engineering plastic PP.
- Prevents access to the main cylinder valve without authorization .
- No need to match your lockout device to varying Dia. and threads of cylinder caps.
- Can be used for the maximum Dia. 80mm of the neck ring.
- Can be locked with 3 padlocks, lock shackle Dia. ≤ 7mm.

Product Selection

Model	Description	Application
BD-Q31	Max 80mm of the neck ring	

BD-Q110 OIL DRUM LOCKOUT

Unit: mm

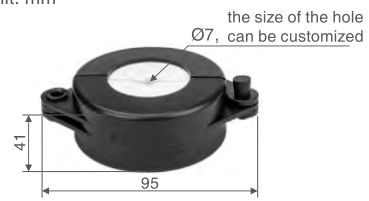

Product Features

- Made of High density polyethylene(HDPE).
- Prevent chemical substances from being discharged into the environment and prevent dirt particles from polluting chemicals.
- Can be locked with 3 padlocks, lock shackle Dia. ≤ 7mm.

Product Selection

Model	Description	Application
BD-Q110	oil drum hole with 82-88mm outer Dia.	

BD-Q120 CLAMP OIL DRUM COVER LOCKOUT

Unit: mm



Product Features

- Made of corrosion resistance of aluminum alloy.
- lock the Items of the barrel safety.
- Installed around the barrel plug flange without risk of cross threading
- Can be locked with padlocks, lock shackle Dia. ≤ 7mm.

Product Selection

Model	Description	Application
BD-Q120	oil drum hole with 72-85mm outer Dia.	

BD-Q130 SPIRAL OIL DRUM LOCKOUT

Unit: mm

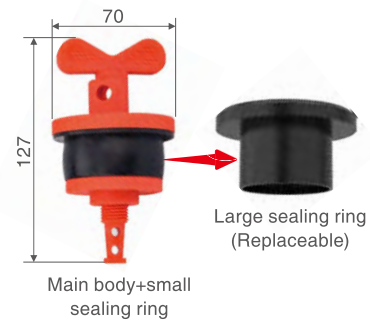

Product Features

- Main body made of PA66+20%GF,Black sealing ring is nitrile rubber .
- Protect the Items of the barrel safety.
- Butterfly nut rotates clockwise ,and expand the gasket, forming a liquid and gas tight seal.
- Can be locked with padlocks, lock shackle Dia. ≤ 7mm.

Product Selection

Model	Description	Application
BD-Q130	small sealing ring for oil drum hole with 55-60mm outer Dia.. Large sealing ring for oil drum hole with 60-70mm outer Dia..	

CABLE LOCKOUT



BD-L01
MULTIPURPOSE CABLE LOCKOUT

Unit: mm



Product Features

- Made from impact resistant engineering plastic nylon PA, can be customized other colors.
- Used stainless steel cable, the outer layer of cable is made from anti-UV PVC.
- The cable can be customized with different length and colors.
- Locked with one padlock, lock shackle Dia. is less than 7mm.

Product Selection

Model	Cable Size	Application
BD-L01	dia 3.5mm x length 2.4m	

BD-L02
MULTIPURPOSE CABLE LOCKOUT

Unit: mm

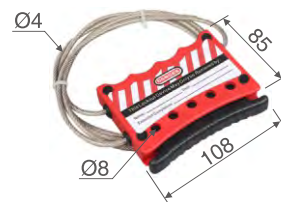

Product Features

- Made from engineering plastic ABS.
- Used stainless steel cable, the outer layer of cable is made from anti-UV PVC.
- Innovative self-locking function, the cable lock is self-locking when it is not operated, to ensure that the cable is not stretched randomly.
- Permanently write labels (Chinese, English or other languages customized) to identify the operator.
- Locked with 5 padlock, lock shackle Dia. is less than 7mm.

Product Selection

Model	Cable Size	Application
BD-L02	dia 4mm x length 1.8m, dia 3mm x length 1.8m	

BD-L11
MULTIPURPOSE CABLE LOCKOUT

Unit: mm



Product Features

- Made from impact resistant engineering plastic PC, other colors can be customized.
- Used cable, the outer layer of cable is made from anti-UV PVC, the cable can be customized with different length and colors.
- Stronger cable, more secure locking, easy to open and lock, and more convenient to use.
- Permanently write labels (Chinese, English or other languages customized) to identify the operator.
- Locked with 4 padlocks, lock shackle Dia. is less than 7mm.

Product Selection

Model	Cable Size	Application
BD-L11-4	dia 4mm x length 1.8m	
BD-L11-6	dia 6mm x length 1.8m	

BD-L12
ADJUSTABLE CABLE LOCKOUT

Unit: mm



Product Features

- Made of PC &ABS .
- It's suitable for all turbine ball valves.
- It's used to lock the industrial ball valve in the closed state to prevent misuse.
- Suitable for padlocks with lock shackle less than 7mm.
- Colour: red. other color can be customize .

Product Selection

Model	Cable Size	Application
BD-L12-1	Insulated cable: dia 3.2mm x length 2.5m	
BD-L12-2	Steel cable: dia 5mm x length 2.5m	

BD-L21
ECONOMIC CABLE LOCKOUT

Unit: mm

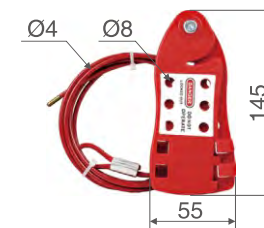

Product Features

- Made from impact resistant engineering plastic nylon PA, can be customized other colors.
- Used stainless steel cable, the outer layer of cable is made from anti-UV PVC.
- The cable can be customized with different length and colors.
- Locked with 4 padlocks, lock shackle Dia. is less than 7mm.

Product Selection

Model	Cable Size	Application
BD-L21	dia 4mm x length 2m	

BD-L22
ADJUSTABLE CABLE LOCKOUT

Unit: mm

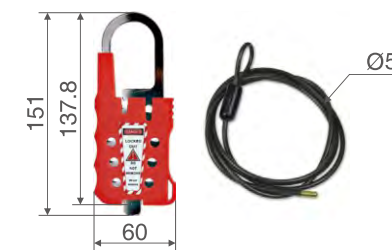

Product Features

- Made of ABS &PC alloy.
- Used stainless steel cable ,the outer layer of cable is made from anti-UV PVC.
- Allow 6 padlocks with lock shackle less than 7mm.
- Colour: red.

Product Selection

Model	Cable Size	Application
BD-L22	dia 5mm x length 1.8m	

BD-L31/L31A
WHEEL TYPE CABLE LOCKOUT

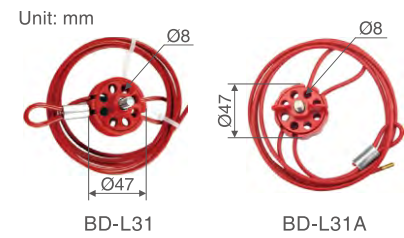

BD-L31 BD-L31A



Product Features

- Made from impact resistant engineering plastic nylon PC .
- Used stainless steel cable, the outer layer of cable is made from anti-UV PVC.
- Cable can be customized other colors. (Red,yellow,blue,green)
- The cable can be customized with different length and colors.
- Locked with several padlocks, lock shackle Dia. is less than 7mm.
- This cable lockout is an ideal device for locking cable device.

Product Selection

Model	Cable Size	Application
BD-L31	dia 4mm x length 2m	
BD-L31A		

BD-L32
WHEEL TYPE CABLE LOCKOUT



Product Features

- The lock body is made of engineering plastic reinforced nylon and copper fittings. Other colors can be customized.
- Used stainless steel cable, the outer layer of cable is made from anti-UV PVC .
- The cable can be customized with different length and colors.
- Comes with a lock handle, easy to use.
- Locked with several padlocks, lock shackle Dia. is less than 7mm.

Product Selection

Model	Cable Size	Application
BD-L32	dia 4mm x length 2m	

BD-L41
AUTOMATIC RETRACTABLE CABLE LOCKOUT



Product Features

- Made of Polycarbonate Plastic(PC).
- Used stainless steel cable, the outer layer of cable is made from anti-UV PVC.
- Automatic retraction, press the winding switch button, the cable can automatic retract; maneuverable, portable, durable.
- Allow 2 padlocks with lock shackle less than 7mm.

Product Selection

Model	Cable Size	Application
BD-L41	dia 2mm x length 1.8m	

BD-L42
MINI CABLE LOCKOUT

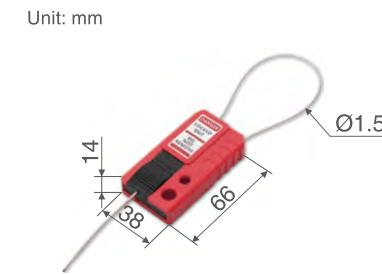

Product Features

- Made from impact resistant engineering plastic nylon PA.
- Used stainless steel cable, the outer layer of cable is made from anti-UV PVC.
- Black parts: When push it up, the cable will be unlocked; When push it down, the cable will be locked. With "LOCK OUT" on red parts for warning.
- The cable can only be tightened up after locking, more convenient to operate.
- Can customized labels. (language customize)
- With 6mm and 8mm Dia. lock holes, suitable for different shackles.

Product Selection

Model	Cable Size	Application
BD-L42	dia 1.5mm x length 0.3m, dia 1.5mm x length 0.5m	

BD-L61
SIMPLE CABLE LOCKOUT

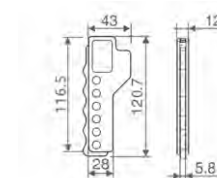
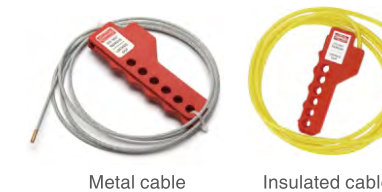

Product Features

- The lockout body is made of engineering plastic nylon PA
- The outer layer of the cable is made of UV-resistant PVC, and the inner material is divided into two materials: insulation and metal (stainless steel);
- Customizable labels. (Chinese, English or multi-language customization)

Product Selection

Model	Cable Size	Application
BD-L61	dia 3mm x length 1.8m, Metal cable dia 4mm x length 1.8m, Metal cable dia 5mm x length 2.4m, Insulated cable	

BD-AL61
SIMPLE ALUMINUM CABLE LOCKOUT

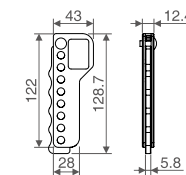

Product Features

- The lock body is made of die-cast aluminum paint;
- It can be locked with 8 safety padlocks with shackle Dia. ≤ 7mm;
- Colour: lacquered silver or lacquered red.

Product Selection

Model	Cable Size	Application
BD-AL61	dia 3mm x length 1.5m, dia 4mm x length 1.5m	

BD-SL61
SIMPLE STAINLESS STEEL
CABLE LOCKOUT

Unit: mm

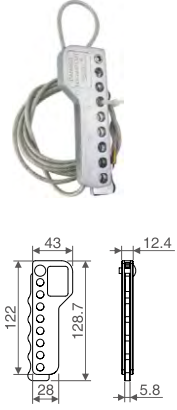

Product Features

- The lock body is made of die-cast stainless steel paint.
- It can be locked with 7 safety padlocks with shackle Dia. ≤7mm.

Product Selection

Model	Cable Size	Application
BD-SL61	dia 3mm x length 1.5m, dia 4mm x length 1.5m	

BD-L62
CABLE LOCKOUT

Unit: mm

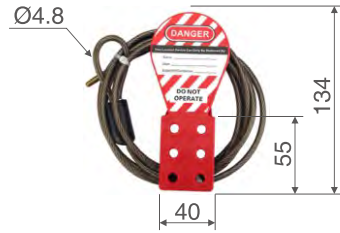

Product Features

- Made of PC material.
- Used stainless steel cable ,the outer layer of cable is made from anti-UV PVC.
- Allow 6 padlocks with lock shackle less than 7mm.
- Colour: red, other colors need to be customized.

Product Selection

Model	Cable Size	Application
BD-L62	dia 5mm x length 1.8m	

LOCKOUT STATION



**BD-B100 SERIES
INTEGRATED LOCKOUT STATION**

Unit: mm

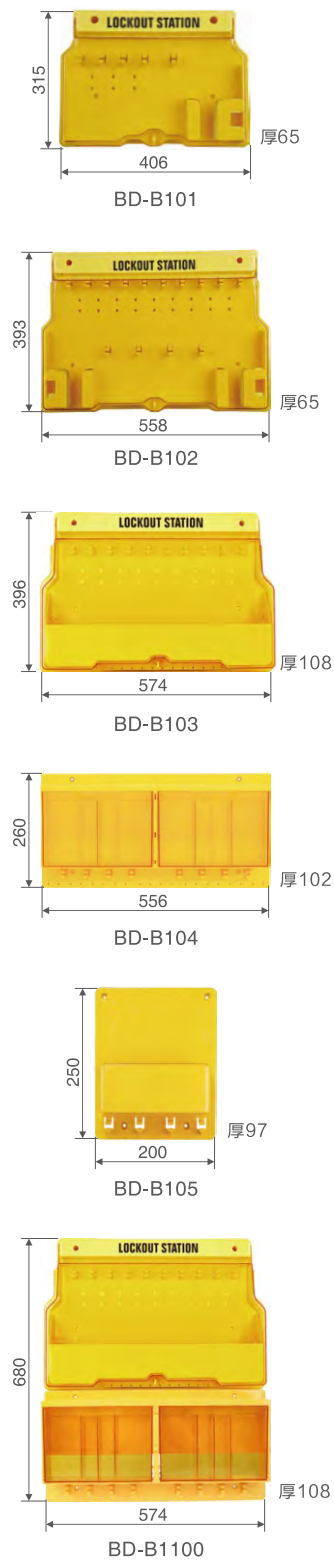

Product Introduction

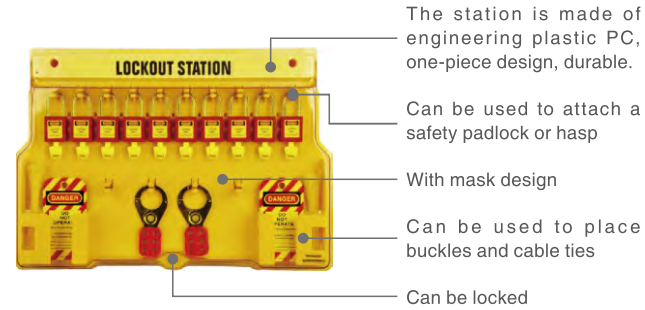

Product Selection

Model	Description
BD-B101	There are 5 hook positions, each of which can accommodate up to 2 padlocks and 4 hasps, and can also accommodate several types of lockouts, tags, cable ties, etc.
BD-B102	There are 14 hook positions, each of which can accommodate up to 2 padlocks and 4 hasps, and can also accommodate several types of lockouts, tags, cable ties, etc.
BD-B103	There are 10 hook positions, each of which can accommodate up to 2 padlocks and 4 hasps, and can also accommodate several types of lockouts, tags, cable ties, etc.
BD-B104	There are 8 hook positions, each of which can accommodate up to 2 padlocks and 4 hasps, and can also accommodate several types of lockouts, tags, cable ties, etc.
BD-B105	There are 4 hook positions, each of which can accommodate up to 2 padlocks and 4 hasps, and can also accommodate several types of lockouts, tags, cable ties, etc.
BD-B106	There are 18 hook positions, each of which can accommodate up to 2 padlocks and 4 hasps, and can also accommodate several types of lockouts, tags, cable ties, etc. (This model is a combination of BD-B103 and BD-B104)

**BD-B200 SERIES
COMBINED LOCK WORKSTATION**

Unit: mm

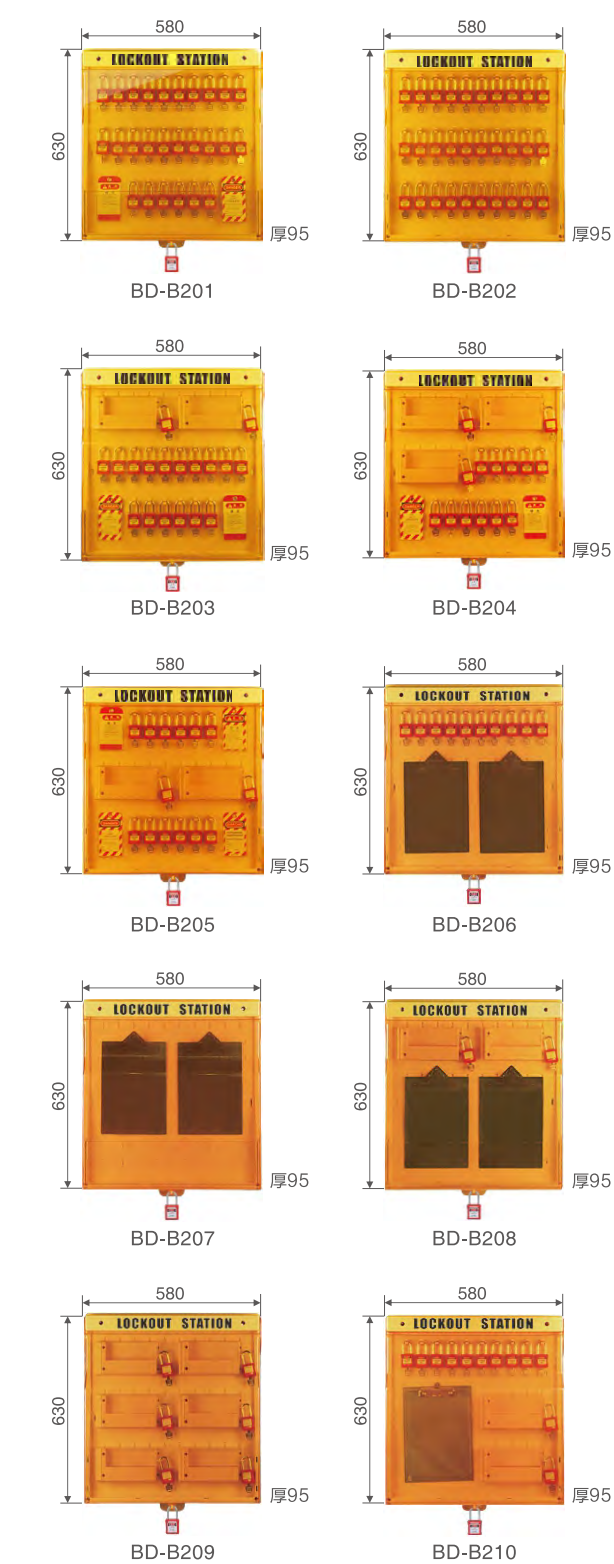

Product Introduction

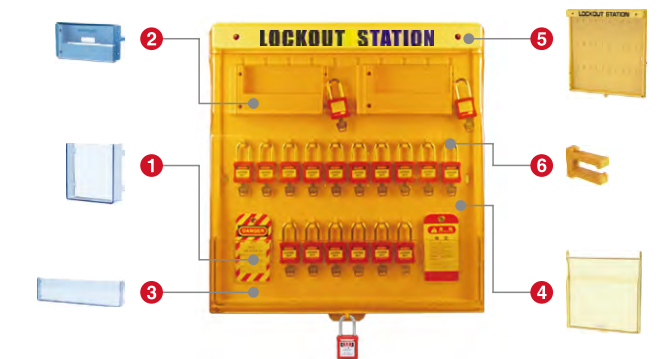

No.	Model	Material	Description
1	BD-B200-1	Engineering Plastic PC	Tag box: Store tags, can be used with hanging board
2	BD-B200-2		Mobile phone box: fixed with individual screws, can be used with hanging board
3	BD-B200-3		Store padlocks or small safety locks for use with pegboards
4	BD-B200-4		Engineering mask: used with hanging board
5	BD-B200-5		Engineering siding: used with face shields
6	BD-B200-6		Hanging plate clip: for hanging safety padlock or hasp

Product Selection

Model	Description
BD-B201	There are 26 hook positions and 2 tag boxes, which can accommodate several padlocks, hasps, tags, cable ties, small locks, etc.
BD-B202	There are 30 hook positions, which can accommodate several padlocks, hasps, etc.
BD-B203	There are 16 hook positions, 2 mobile phone boxes, and 2 tag boxes, which can accommodate several padlocks, hasps, tags, cable ties, small locks, etc.
BD-B204	There are 12 hook positions, 3 mobile phone boxes, and 2 tag boxes, which can accommodate several padlocks, hasps, tags, cable ties, small locks, etc.
BD-B205	There are 12 hook positions, 2 mobile phone boxes, and 4 tag boxes, which can accommodate several padlocks, hasps, tags, cable ties, small locks, etc.
BD-B206	There are 10 hook positions, 2 A4 writing boards, which can accommodate several padlocks, hasps, work tickets, etc.
BD-B207	There are 2 A4 size writing boards, which can accommodate several work tickets, hang tags, cable ties, etc.
BD-B208	There are 2 mobile phone boxes, 2 A4 writing boards, which can accommodate several work tickets, tags, cable ties, etc.
BD-B209	There are 6 mobile phone boxes.
BD-B210	There are 10 hook positions, 2 mobile phone boxes, and 1 A4 writing board, which can accommodate several padlocks, hasps, work tickets, etc.

**BD-B301/B301
OPEN LOCKOUT STATION**

Unit: mm

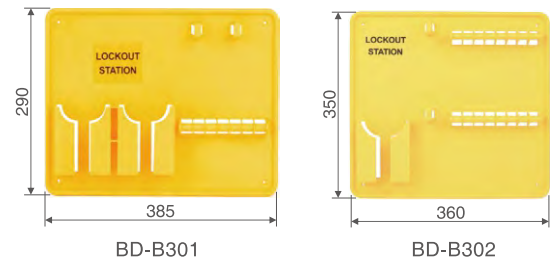

Product Features

- Made of PP material, the product is wear-resistant, corrosion-resistant and low-temperature resistant;
- It can be hung with various buckles, padlocks, hang tags, cable ties, etc.

Product Selection

Model	Description
BD-B301	2 hasp lock positions, 7 padlock positions, 2 tag positions
BD-B302	2 hasp lock positions, 16 padlock positions, 1 tag position

**BD-B31/B32/B33/B34
PADLOCK STATION**

Unit: mm

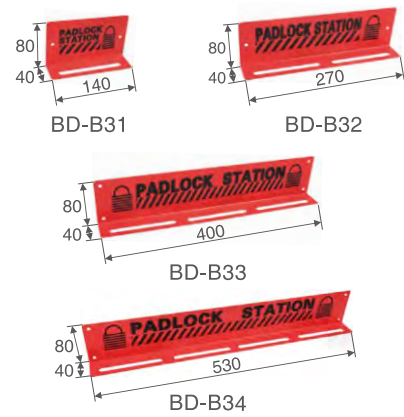

Product Features

- Made of steel plate with high temperature spray surface.
- It has four sizes. Convenient for daily management of padlocks.

Product Selection

Model	Description
BD-B31	Supply with 5 padlocks
BD-B32	Supply with 10 padlocks
BD-B33	Supply with 15 padlocks
BD-B34	Supply with 20 padlocks

**BD-B41/B42
PORTABLE PADLOCK LOCKOUT**

Unit: mm

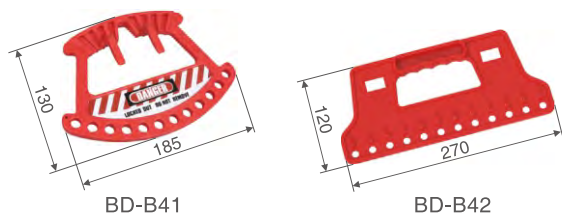

Product Features

- Made from injected engineering plastic reinforced nylon.
- BD-B41 has warning labels.
- The padlock and key can be carried and used at the same time.

Product Selection

Model	Description
BD-B41	Suitable for hanging up to 12 padlocks with lock shackle, other colors can be customized
BD-B42	

**BD-B51
SAFETY TAG STATION**

Unit: mm

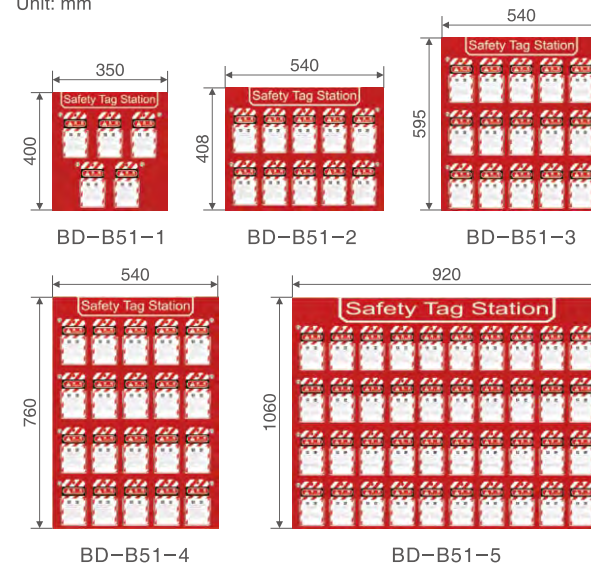

Product Features

- It is composed of steel plate with high temperature spray surface and a tag box made of engineering plastic PC.
- Can customize 5,10,15, 20 tagout boxes.
- Can be customized different colors.

Product Selection

Model	Description
BD-B51-1	Can accommodate 5 tagout boxes, each tagout box can accommodate 20 pieces tagout.
BD-B51-2	Can accommodate 10 tagout boxes, each tagout box can accommodate 20 pieces tagout
BD-B51-3	Can accommodate 15 tagout boxes, each tagout box can accommodate 20 pieces tagout
BD-B51-4	Can accommodate 20 tagout boxes, each tagout box can accommodate 20 pieces tagout
BD-B51-5	Can accommodate 50 tagout boxes, each tagout box can accommodate 20 pieces tagout

**BD-B3
PADLOCK STATION**

Unit: mm

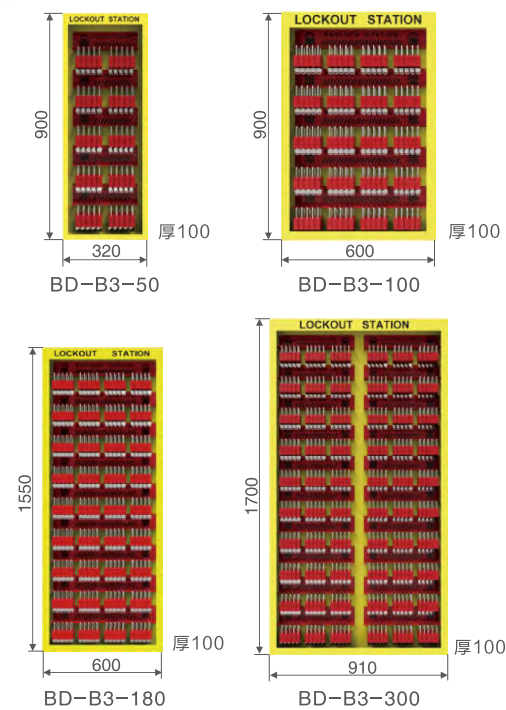

Product Selection

Model	Description
BD-B3-50	Can accommodate 50 padlocks, using with BD-B32(Quantity: 5)
BD-B3-100	Can accommodate 100 padlocks, using with BD-B32(Quantity: 5)
BD-B3-180	Can accommodate 180 padlocks, using with BD-B32(Quantity: 5)
BD-B3-300	Can accommodate 300 padlocks, using with BD-B32(Quantity: 5)

**BD-B4
PADLOCK STATION**

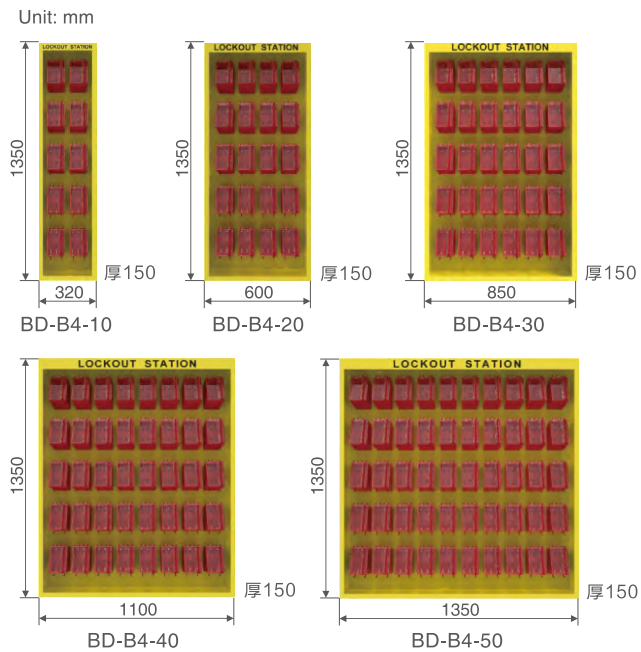

Product Selection

Model	Description
BD-B4-10	Can accommodate 10 boxes
BD-B4-20	Can accommodate 20 boxes
BD-B4-30	Can accommodate 30 boxes
BD-B4-40	Can accommodate 40 boxes
BD-B4-50	Can accommodate 50 boxes

**BD-B60~B66
KEY MANAGEMENT STATION**



Product Introduction

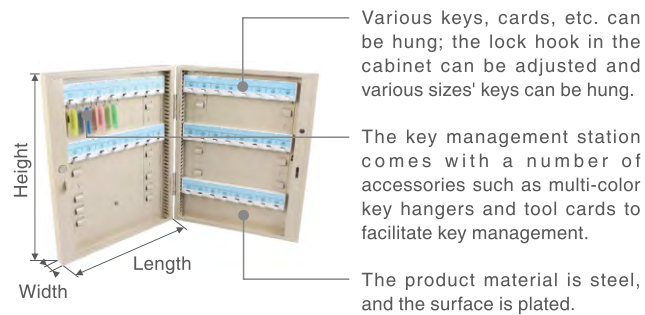

Product Selection

Model	Description
BD-B60	20 positions key management station, Length 215mm x Width 50mm x Height 385mm
BD-B61	32 positions key management station, Length 305mm x Width 50mm x Height 385mm
BD-B62	48 positions key management station, Length 305mm x Width 50mm x Height 500mm
BD-B63	60 positions key management station, Length 370mm x Width 60mm x Height 500mm
BD-B64	80 positions key management station, Length 370mm x Width 60mm x Height 620mm
BD-B65	160 positions key management station, Length 385mm x Width 100mm x Height 620mm
BD-B66	240 positions key management station, Length 385mm x Width 145mm x Height 620mm

**BD-B7
OPEN LOCKOUT STATION**

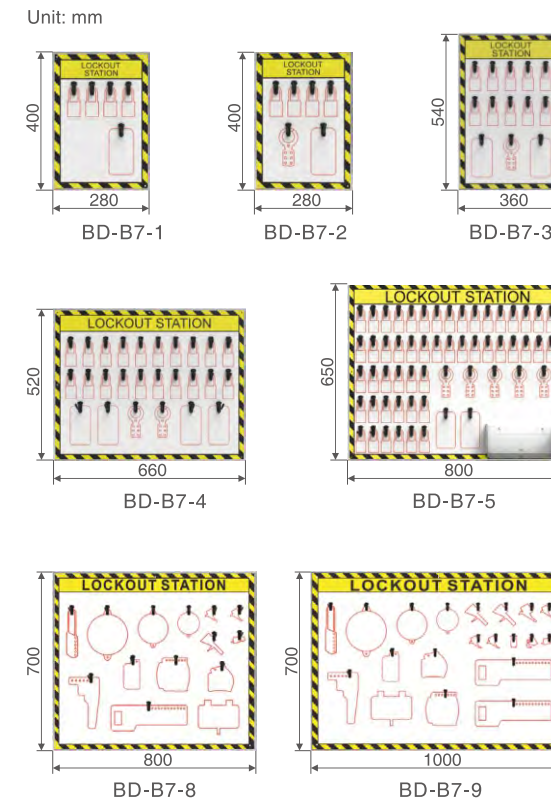

Product Introduction

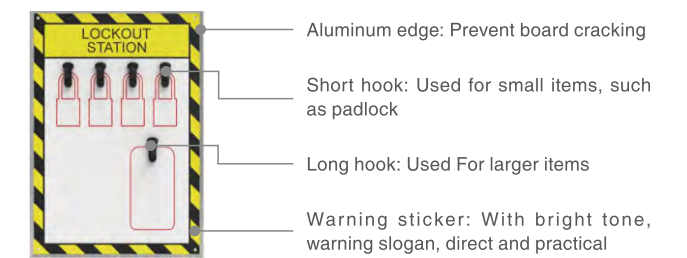

Product Features

- Suitable for small companies and large departments to manage centrally.
- The board is made from hard plastic PVC, outer frame is made of aluminum in order to prevent it from falling down.
- Shadow contour is convenient to inventory and storage.
- Can customize design and logo etc.

**BD-B901
PULL ROD TYPE MOVABLE LOCKOUT STATION**



Product Introduction

Movable lockout station is divided into three layers, which is convenient for sorting and packing during maintenance. It has a thick and wear-resistant big roller, and the lockout station can move freely.



BD-X01/X01T
PORTABLE STEEL SAFETY LOCKOUT BOX

Unit: mm

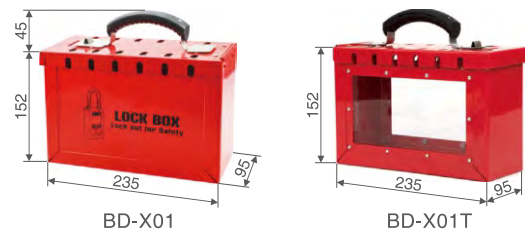

Product Features

- Made of steel plate with high temperature spray surface and a foldable handle.
- Several people can lock the important parts at the same time, can accommodate 12 padlocks.
- BD-X01T has transparent acrylic visual door panel, realizing visual management.

Product Selection

Model	Description
BD-X01	Can be used as mini portable lockout box, can accommodate several tagouts, hasps, mini lockouts etc.
BD-X01T	

BD-X02
PORTABLE STEEL SAFETY LOCKOUT BOX

Unit: mm



Product Features

- Made of steel plate with high temperature spray surface, the X02 is with a stainless steel handle.
- Several people can lock the important parts at the same time, can accommodate 12 padlocks.
- Can be used as mini portable lockout box, can accommodate several tagouts, hasps, mini lockouts etc.

Product Selection

Model	Description
BD-X02	Can be used as mini portable lockout box, can accommodate several tagouts, hasps, mini lockouts etc.

BD-X03
PORTABLE STEEL SAFETY LOCKOUT BOX

Unit: mm



Product Features

- Made of steel plate with high temperature spray surface, handle material is stainless steel and nylon.
- Device design for key store when large scale equipment shut down.
- Double function: wall-mounted or portable
- Up to 14 workers can lock it at the same time.
- Can be customized other colors.

Product Selection

Model	Description
BD-X03	Can be used as mini portable lockout box; can accommodate several tagouts, hasps, mini lockouts etc. Integrated storage space for orderly storage of up to 12 padlocks or hundreds of keys.

BD-X04
PORTABLE STEEL SAFETY LOCKOUT BOX

Unit: mm

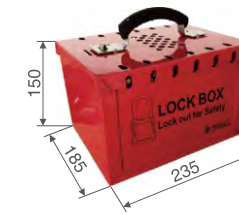

Product Features

- Made of steel plate with high temperature spray surface, the X04 is with a stainless steel and nylon handle.
- Several people can lock the important parts at the same time, can accommodate 12 padlocks.

Product Selection

Model	Description
BD-X04	Can be used as mini portable lockout box; can accommodate several tags, hasps, mini lockouts etc.

BD-X07
LOCKOUT MANAGEMENT STATION

Unit: mm

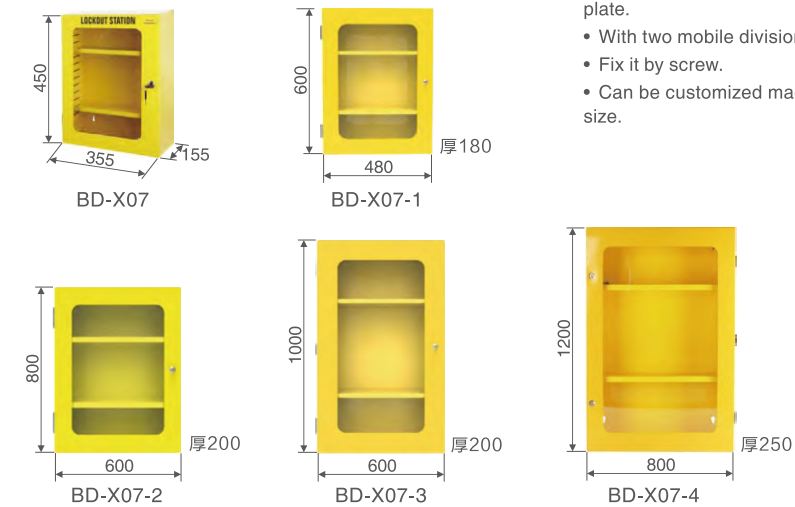

Product Features

- Made from surface high temperature spraying plastic treatment steel plate.
- With two mobile division plates, can set the division space flexibly.
- Fix it by screw.
- Can be customized made non-perspective panel. Can customize bigger size.

BD-X08/X09
LOCKOUT MANAGEMENT STATION

Unit: mm

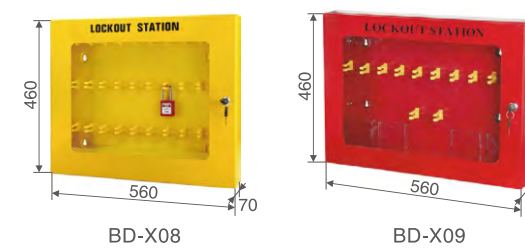

Product Features

- Made from surface high temperature spraying plastic treatment steel plate.
- Lockout management available.
- Can be customized opaque panels.

Product Selection

Model	Description
BD-X08	30 hook positions, each of which can hang two padlocks or hasps
BD-X09	22 hook positions and 4 tag boxes, each hook position can hang 2 padlocks and 2 hasps, and can hold about 40 tags.

**BD-X11/X12
PADLOCK STATION**

Unit: mm

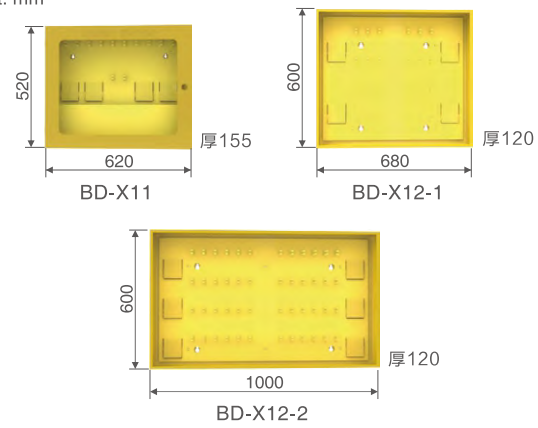

Product Features

- Made from surface high temperature spraying plastic treatment steel plate.
- Lockout management available.

Product Selection

Model	Description
BD-X11	12 hook positions and 4 card slots, each hook position can hang two padlocks or hasps.
BD-X12-1	24 hook positions and 4 card slots, each hook position can hang two padlocks or hasps.
BD-X12-2	48 hook positions and 6 card slots, each hook position can hang two padlocks or hasps.

**BD-X14/X15
HANGING PLASTIC SAFETY LOCKOUT BOX**

Unit: mm

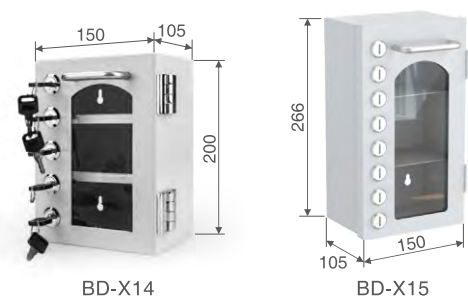

Product Features

- Made from surface high temperature spraying plastic treatment steel plate.
- Lockout management available.

Product Selection

Model	Description
BD-X14	With 5 cylinders
BD-X15	With 8 cylinders

**BD-X21
SMALL HANGING PLASTIC SAFETY LOCKOUT BOX**

Unit: mm

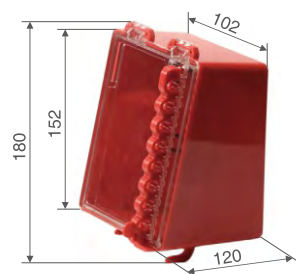

Product Features

- Made of engineering plastic ABS and PC.
- With transparent cover.
- Can be locked by padlocks with shackle Dia. less than 7mm
- Can be locked by 8 safety padlocks at the same time, convenient for management.

Product Selection

Model	Description
BD-X21	It has 6 hooks inside and 2 hooks outside.

**BD-X22
PORTABLE MULTIPURPOSE PLASTIC SAFETY LOCKOUT BOX**

Unit: mm



Product Features

- Made of engineering plastic ABS and PC.
- With transparent cover.
- Can be locked by padlocks with shackle Dia. less than 7mm
- Can be locked by 12 safety padlocks at the same time, convenient for management.

Product Selection

Model	Description
BD-X22	It has 6 hooks inside

**BD-X23
PORTABLE COMBINATION LOCKOUT BOX**

Unit: mm



Product Selection

Model	Description
BD-X23A	With 10 padlock positions and 6 hook positions, can accommodate several padlocks, hasps, mini lockouts etc.
BD-X23B	With 10 padlock positions, 2 hook positions and 2 tags boxes, can accommodate several tagouts, hasps, mini lockouts etc.
BD-X23B	With 10 padlock positions and 3 tags boxes, can accommodate several padlocks, hasps, mini lockouts etc.
BD-X23D	With 10 padlock positions and 1 tags box, can accommodate several padlocks, hasps etc.
BD-X23E	With 12 padlock positions, can accommodate several padlocks, hasps etc.

Remark: This product can be carried in hand or hung on the wall. Lockout kit can be locked.

BD-X24
WALL MOUNTED MULTIFUNCTIONAL LOCKBOX

Unit: mm



Product Features

- Made of steel plate with high temperature spray surface, it is not easy to oxidize and rust.
- Several people can lock the important parts at the same time, can accommodate 12 padlocks.
- It has transparent acrylic visual door panel, realizing visual management.

Product Selection

Model	Description
BD-X24	Can be used as mini portable lockout box; can accommodate several tags, hasps, mini lockouts etc.

BD-X26
WALL-MOUNTED FUNCTIONAL SAFETY LOCKOUT BOX

Unit: mm

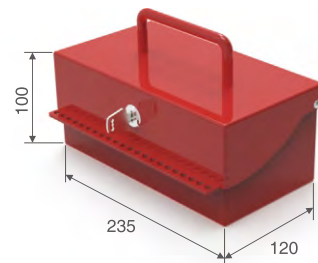

Product Features

- The high-strength steel plate is stamped and the surface is treated with high-temperature plastic spray, which is not easy to oxidize and rust.
- Several people can lock the important parts at the same time, can accommodate 22 padlocks.

Product Selection

Model	Description
BD-X26	Can be used as mini portable lockout box; can accommodate several tags, hasps, mini lockouts etc.

BD-X27
MULTIFUNCTIONAL SAFETY LOCKOUT BOX

Unit: mm

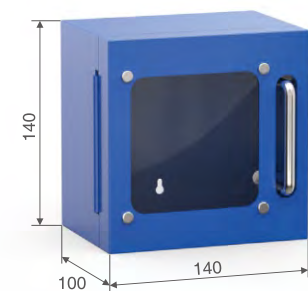

Product Features

- Made of cold rolled steel plate is stamped and the surface is treated with high-temperature plastic spray, which is not easy to oxidize and rust.
- Several people can lock the important parts at the same time.

Product Selection

Model	Description
BD-X26	Can be used as mini portable lockout box; can accommodate several tags, hasps, mini lockouts etc.

BD-X60/X61/X62
LOCKOUT MANAGEMENT STATION

Unit: mm



Product Features

- Made of cold rolled steel plate is stamped and the surface is treated with high-temperature plastic spray.
- Double function: wall-mounted or portable.
- Several people can lock the important parts at the same time, can accommodate 22 padlocks.
- Other colors can be customized.

Product Selection

Model	Description
BD-X60	Composed of BD-X61 and BD-X62; With 1x A4 paper clip and 1 x BD-B42 hanger, can accommodate several job tickets, padlocks, keys, etc.
BD-X61	With 1x A4 paper clip and 1 x BD-B42 hanger, can accommodate several job tickets
BD-X62	With 1 x BD-B42 hanger, can accommodate several job tickets, padlocks, keys, etc.

BD-SX10
LOCKOUT STATION

Unit: mm

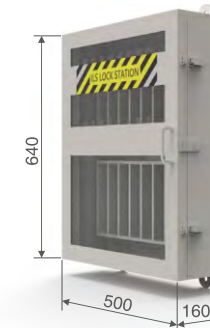

Product Features

- Made of cold rolled steel plate is stamped and the surface is treated with high-temperature plastic spray, which is not easy to oxidize and rust.
- It has transparent acrylic visual door panel, realizing visual management.

Product Selection

Model	Description
BD-SX10	can accommodate 16 sets padlocks, 8pcs each set.

BD-M01
LARGE LOCKOUT DISPLAY STATION

Unit: mm



Product Features

- Made of steel plate with high temperature spray surface, it is not easy to oxidize.

Product Selection

Model	Description
BD-M01	It consists of three parts: upper, middle and lower. The upper layer displays industrial electrical lockouts, the middle layer displays valves and other lockouts, and the lower layer is the storage location for lockouts.

BD-M02
MOVEABLE LOCKOUT DISPLAY STAND

Unit: mm

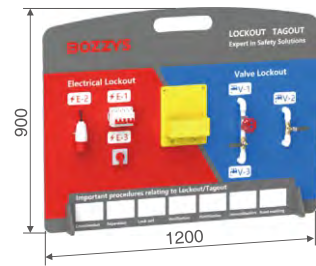

Product Features

- Made of KT plate.

Product Selection

Model	Description
BD-M02	Display the electrical lockout and valve lockout and key steps in the "lockout tagout" process.

BD-S03
COLLECTIVE STORAGE CABINETS

Unit: mm

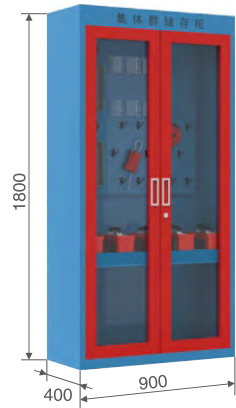

Product Features

- Made of sheet metal steel, surface is spray treated, not easy to oxidize.

Product Selection

Model	Description
BD-S03	It can store all kinds of lockout, can store 10 groups of padlock (10pcs / group), 10 tag boxes, 15 padlocks and several lockout boxes.

BD-B3-D1
LOCKOUT MANAGEMENT STATION

Unit: mm

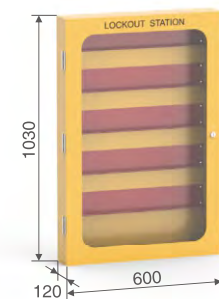

Product Features

- Made of Q235 cold rolled steel plate, the surface is treated by high temperature spray, not easy to oxidize and rust.
- Transparent organic glass door panel, to achieve visual management.

Product Selection

Model	Description
BD-B3-D1	There are 5 lock hangers, which can hold 100 padlocks; 4 tag boxes, which can accommodate several tags, cable ties, etc

BD-X-D1
LOCKOUT MANAGEMENT STATION

Unit: mm

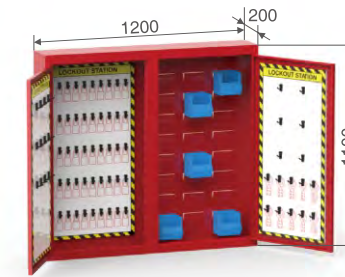

Product Features

- Made of Q235 cold rolled steel plate, the surface is treated by high temperature spray, not easy to oxidize and rust.

Product Selection

Model	Description
BD-X-D1	There are 3 customized BD-B7 base plates and 8 storage boxes, which can accommodate several padlocks, hasps, tags, cable ties, small locks, etc

BD-X-D2
LOCKOUT MANAGEMENT STATION

Unit: mm

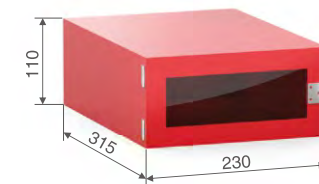

Product Features

- Made of Q235 cold rolled steel plate, the surface is treated by high temperature spray, not easy to oxidize and rust.
- Transparent acrylic door panel, to achieve visual management.

Product Selection

Model	Description
BD-X-D2	Can accommodate several padlocks, hasps, small locks, etc

BD-X-D3
LOCKOUT MANAGEMENT STATION

Unit: mm

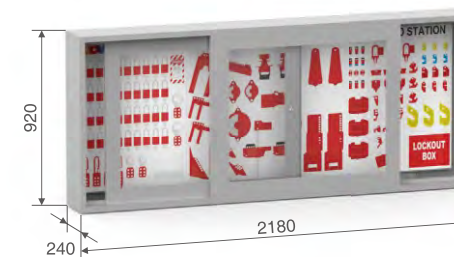

Product Features

- Made of Q235 cold rolled steel plate, the surface is treated by high temperature spray, not easy to oxidize and rust.
- Transparent acrylic door panel, to achieve visual management.

Product Selection

Model	Description
BD-X-D3	Customized BD-B7 base plates, can accommodate several padlocks, hasps, tags, cable ties, small locks, etc

BD-X-D4
LOCKOUT MANAGEMENT STATION

Unit: mm



Product Features

- Made of Q235 cold rolled steel plate, the surface is treated by high temperature spray, not easy to oxidize and rust.
- Transparent acrylic door panel, to achieve visual management.

Product Selection

Model	Description
BD-X-D4	There are 4 padlock boxes and 6 tag boxes, which can accommodate several padlocks, hasps, keys, tags, cable ties, small locks, etc

BD-X-D5
LOCKOUT MANAGEMENT STATION

Unit: mm

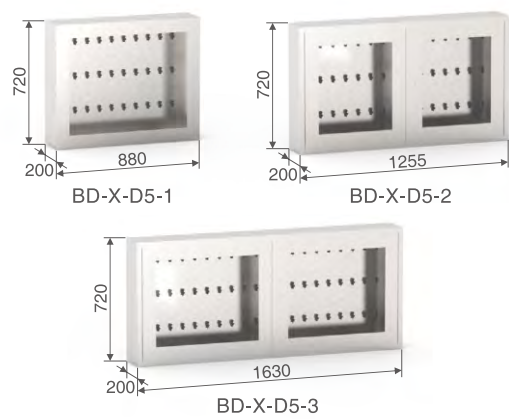

Product Features

- Made of Q235 cold rolled steel plate, the surface is treated by high temperature spray, not easy to oxidize and rust.
- Transparent acrylic door panel, to achieve visual management.

Product Selection

Model	Description
BD-X-D5-1	There are 30 hooks, which can accommodate several padlocks, hasp, etc
BD-X-D5-2	There are 45 hooks, which can accommodate several padlocks, hasp, etc
BD-X-D5-3	There are 60 hooks, which can accommodate several padlocks, hasp, etc

BD-X07-D1
LOCKOUT MANAGEMENT STATION

Unit: mm



Product Features

- Made of Q235 cold rolled steel plate, the surface is treated by high temperature spray, not easy to oxidize and rust.
- Transparent organic glass door panel, to achieve visual management.

Product Selection

Model	Description
BD-X07-D1	There are 5 lock hangers, which can hold 100 padlocks

BD-X07-D3
LOCKOUT MANAGEMENT STATION

Unit: mm



Product Features

- Made of Q235 cold rolled steel plate, the surface is treated by high temperature spray, not easy to oxidize and rust.
- Transparent acrylic door panel, to achieve visual management.

Product Selection

Model	Description
BD-X07-D3	There are 2 partitions, which can be freely disassembled and combined; It can accommodate several padlocks, hasps, small locks, etc

BD-X07-D5
LOCKOUT MANAGEMENT STATION

Unit: mm



Product Features

- Made of Q235 cold rolled steel plate, the surface is treated by high temperature spray, not easy to oxidize and rust.
- Transparent acrylic door panel, to achieve visual management.

Product Selection

Model	Description
BD-X07-D5	There are 50 black hooks, 3 large yellow hooks, which can accommodate several padlocks, hasps, tags, cable ties, small locks, etc

BD-X09-D2
LOCKOUT MANAGEMENT STATION

Unit: mm

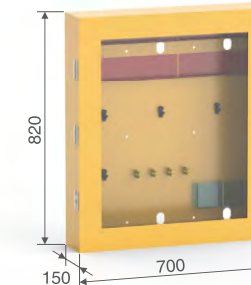

Product Features

- Made of Q235 cold rolled steel plate, the surface is treated by high temperature spray, not easy to oxidize and rust.
- Transparent organic glass door panel, to achieve visual management.

Product Selection

Model	Description
BD-X09-D2	Built-in 4 lock hangers, which can accommodate 50 padlocks; There are 4 small black hooks, 4 large yellow hooks, 2 tag boxes, 1 partition, which can accommodate several hasps, tags, cable ties, small locks, etc

BD-X16-D1
LOCKOUT MANAGEMENT STATION

Unit: mm

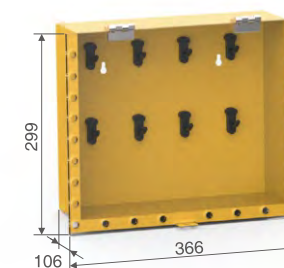

Product Features

- Made of Q235 cold rolled steel plate, the surface is treated by high temperature spray, not easy to oxidize and rust.
- Can realize multiple people to lockout the important parts at the same time, can hang up to 24 padlocks.
- Transparent PC door panel, to achieve visual management.

Product Selection

Model	Description
BD-X16-D1	There are 8 hooks, which can accommodate several padlocks, hasps, etc

WAIST BAG / COMBINATION BAG



BD-Z01 SAFETY LOCKOUT WAIST BAG

Unit: mm



Product Features

- Made of wear-resistant polyester cloth.
- Can customize the surface label content of bag for customers, such as XX department of XX company.

BD-Z02 SAFETY LOCKOUT HANDBAG

Unit: mm



Product Features

- Made of wear-resistant polyester cloth.
- Can customize the surface label content of bag for customers, such as XX department of XX company.

BD-Z03 SAFETY LOCKOUT PORTABLE BOX

Unit: mm



Product Features

- Made of coated iron sheet and engineering plastic PP.
- Can customize the surface label content of bag for customers, such as XX department of XX company.

BD-Z04 SAFETY LOCKOUT HANDBAG

Unit: mm



Product Features

- Made of wear-resistant polyester cloth.
- Can customize the surface label content of bag for customers, such as XX department of XX company.

BD-Z05 SAFETY LOCKOUT HANDBAG

Unit: mm



Product Features

- Made of wear-resistant polyester cloth.
- Can customize the surface label content of bag for customers, such as XX department of XX company.

BD-Z06
SAFETY LOCKOUT WAIST BAG

Unit: mm



Product Features

- Made of engineered Oxford fabric.
- Can customize the surface label content of bag for customers, such as XX department of XX company.

BD-Z30
SAFETY LOCKOUT PORTABLE BOX

Unit: mm



Product Features

- Made of ABS.
- There's a partition inside, can customize the lockout kit for customers.

BD-Z10
SAFETY LOCKOUT COMBINATION BAG



Product List

Description	Part code	Qty.
Safety lockout waist bag	BD-Z01	1
Short steel shackle safety padlock (Blue)	BD-G53	1
Nylon shackle safety padlock (Black)	BD-G15	1
Double-end aluminum hasp	BD-K61	1
Nylon lockout hasp	BD-K44	1
Multi-function circuit breaker lockout	BD-D14	1
Multi-function circuit breaker lockout	BD-D15	1
Safety tag	BD-P01	10

BD-Z11
SAFETY LOCKOUT COMBINATION BAG



Product List

Description	Part code	Qty.
Safety lockout handbag	BD-Z02	1
Short steel shackle safety padlock (Blue)	BD-G53	1
Nylon shackle safety padlock (Black)	BD-G15	1
Double-end aluminum hasp	BD-K61	1
Nylon lockout hasp	BD-K44	1
Multi-function circuit breaker lockout	BD-D14	1
Multi-function circuit breaker lockout	BD-D15	1
Safety tag	BD-P01	10
Adjustable ball valve lockout	BD-F01	1
Gate valve lockout	BD-F11	1

BD-Z12
SAFETY LOCKOUT COMBINATION BAG



Product List

Description	Part code	Qty.
Safety lockout handbag	BD-Z02	1
Nylon shackle safety padlock (Black)	BD-G15	1
Steel shackle safety padlock (Red)	BD-G01	1
Steel shackle safety padlock (Yellow)	BD-G02	1
Nylon lockout hasp	BD-K42	1
Double-end aluminum hasp	BD-K61	1
Aluminum lockout hasp	BD-K11	1
Adjustable ball valve lockout	BD-F01	1
Gate valve lockout	BD-F11	1
Automatic retractable cable lockout	BD-L41	1
Multi-function circuit breaker lockout	BD-D14	2
Multi-function circuit breaker lockout	BD-D15	2
Safety tag	BD-P01	10

BD-Z13
SAFETY LOCKOUT COMBINATION BAG



Product List

Description	Part code	Qty.
Safety lockout handbag	BD-Z02	1
Nylon shackle safety padlock (Yellow)	BD-G12	1
Nylon shackle safety padlock (Black)	BD-G15	1
Nylon shackle safety padlock (Orange)	BD-G17	1
Long nylon shackle safety padlock (Green)	BD-G34	1
Nylon lockout hasp	BD-K43	1
Nylon lockout hasp	BD-K44	1
Aluminum lockout hasp	BD-K11	1
Multi-function circuit breaker lockout	BD-D14	2
Multi-function circuit breaker lockout	BD-D15	2
Large type circuit breaker lockout	BD-D16	1
Adjustable cable lockout (4mm)	BD-L11	1
Electrical plug lockout (Medium)	BD-D42	1
Safety tag	BD-P01	10

BD-Z14
SAFETY LOCKOUT COMBINATION BOX



Product List

Description	Part code	Qty.
Safety lockout portable box	BD-Z30	1
Steel shackle safety padlock	BD-G01	5
Double-end aluminum hasp	BD-K61	2
Nylon lockout hasp	BD-K43	1
Nylon lockout hasp	BD-K44	1
Industrial water proof plug lockout	BD-D46	1
Multi-function circuit breaker lockout	BD-D14	4
Multi-function circuit breaker lockout	BD-D15	2
Large type circuit breaker lockout	BD-D16	1
Automatic retractable cable lockout	BD-L41	1
Adjustable gate valve lockout	BD-F16	1
Safety tag	BD-P01	10

BD-Z15
SAFETY LOCKOUT COMBINATION BOX



Product List

Description	Part code	Qty.
Safety lockout portable box	BD-Z30	1
Aluminum lockout hasp (Red)	BD-K53	1
PA coated steel hasp	BD-K01	1
PA coated steel hasp	BD-K02	1
Nylon lockout hasp	BD-K42	1
Aluminum lockout hasp	BD-K11	1
Aluminum lockout hasp	BD-K12	1
Clamp-on breaker lockout (Small)	BD-D11X	1
Clamp-on breaker lockout (Medium)	BD-D12X	1
Clamp-on breaker lockout (Large)	BD-D13X	1
Miniature circuit breaker lockout	BD-D01	1
Miniature circuit breaker lockout	BD-D02	1
Miniature circuit breaker lockout	BD-D03	1
Miniature circuit breaker lockout	BD-D04	1
Steel shackle safety padlock	BD-G01	5
Nylon shackle safety padlock	BD-G11	5
Electrical plug lockout (Medium)	BD-D42	1
Electrical plug lockout (Large)	BD-D43	1
Emergency stop lockout	BD-D51	1
Emergency stop lockout	BD-D52	1
Emergency stop lockout	BD-D53	1
Safety tag	BD-P01	10

BD-Z16
SAFETY LOCKOUT KIT



Product List

Description	Part code	Qty.
Lockout station	BD-B201	1
Gate valve lockout	BD-F11	1
Gate valve lockout	BD-F12	1
Gate valve lockout	BD-F13	1
Gate valve lockout	BD-F14	1
Gate valve lockout	BD-F15	1
Flashlight (without battery)	SP-4	1
Safety lockout portable box	BD-Z30	1
Aluminum lockout hasp (Red)	BD-K53	1
PA coated steel hasp	BD-K01	1
PA coated steel hasp	BD-K02	1
Nylon lockout hasp	BD-K42	1
Aluminum lockout hasp	BD-K11	1
Aluminum lockout hasp	BD-K12	1
Clamp-on breaker lockout (small)	BD-D11	1
Clamp-on breaker lockout (Medium)	BD-D12	1
Clamp-on breaker lockout (Large)	BD-D13	1
Miniature circuit breaker lockout	BD-D01	1
Miniature circuit breaker lockout	BD-D02	1
Miniature circuit breaker lockout	BD-D03	1
Miniature circuit breaker lockout	BD-D04	1
Steel shackle safety padlock (Red)	BD-G01	5
Nylon shackle safety padlock (Red)	BD-G11	5
Electrical plug lockout (Medium)	BD-D42	1
Electrical plug lockout (Large)	BD-D43	1
Emergency stop lockout	BD-D51	1
Emergency stop lockout	BD-D52	1
Emergency stop lockout	BD-D53	1
Safety tag	BD-P01	10

BD-Z19
SAFETY LOCKOUT COMBINATION BAG



Product List

Description	Part code	Qty.
Safety lockout handbag	BD-Z04	1
Steel shackle safety padlock (Red)	BD-G01	6
Medium circuit breaker lockout	BD-D17	4
Medium circuit breaker lockout	BD-D18	2
Aluminum lockout hasp (Red)	BD-K54	1
Adjustable cable lockout (4mm)	BD-L11	1
Electrical plug lockout (Small)	BD-D41A	1
Electrical plug lockout (Large)	BD-D42A	1
Universal wall-type switch lockout	BD-D23	2
Steel hasp with hook	BD-K21	1
Gun lock	BD-QS01	2
Safety tag	BD-P01	10

BD-Z20
SAFETY LOCKOUT COMBINATION BAG



Product List

Description	Part code	Qty.
Safety lockout handbag	BD-Z05	1
Nylon shackle safety padlock (Red)	BD-G11	1
Nylon lockout hasp	BD-K43	1
Medium circuit breaker lockout	BD-D17	1
Medium circuit breaker lockout	BD-D18	1
Clamp-on breaker lockout (Medium)	BD-D12X	1
Miniature circuit breaker lockout	BD-D01	1
Miniature circuit breaker lockout	BD-D02	1
Miniature circuit breaker lockout	BD-D03	1
Miniature circuit breaker lockout	BD-D04	1
Simple circuit breaker lockout	BD-D05-1	1
Simple circuit breaker lockout	BD-D05-2	1
Safety tag	BD-P01	10

BD-Z22
SAFETY LOCKOUT COMBINATION BAG



Product List

Description	Part code	Qty.
Safety lockout waist bag	BD-Z06	1
Gun lock	BD-QS01	1
Steel hasp with hook	BD-K21	1
Medium circuit breaker lockout	BD-D17	2
Medium circuit breaker lockout	BD-D18	1
Nylon shackle safety padlock (Red)	BD-G11	1
Safety tag	BD-P01	10

LEAD BLOCKADE

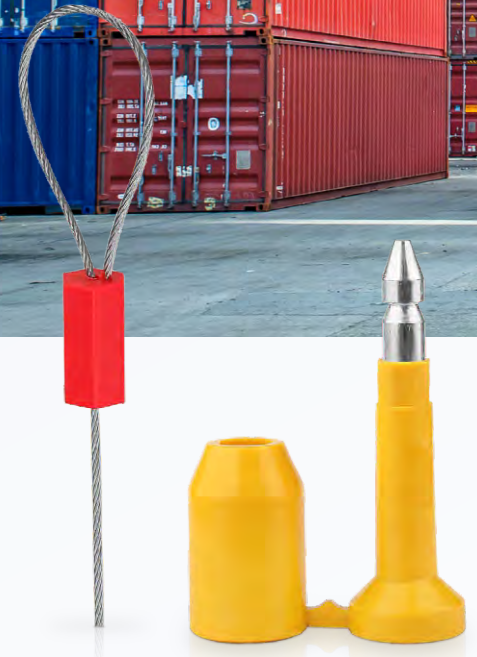

BD-QF01 HEXAGONAL PLASTIC LEAD SEAL LOCK

Unit: mm

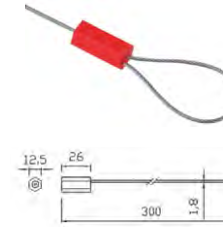

Product Features

- Coated with new ABS eco-friendly plastic, core of lock body is zinc alloy.
- Lock cable material is aviation steel cable, Dia. is 1.8mm.
- The maximum tension can up to 200KG.
- Can customize colors, any text graphics, laser printing, heat transfer printing.

Product Selection

Part code	Description
BD-QF01	Standard steel cable length is 300mm, can be customized.

BD-QF02 SQUARE PLASTIC LEAD SEAL LOCK

Unit: mm

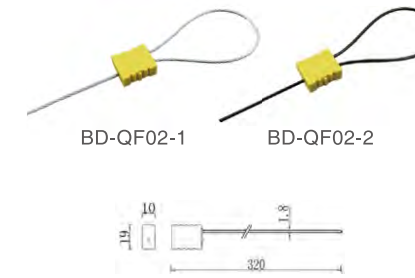

Product Features

- Coated with new ABS eco-friendly plastic, core of lock body is zinc alloy.
- Aviation steel cable Dia. is 1.8mm, black plastic coated steel cable Dia. is 2.0mm.
- The maximum tension can up to 200KG.
- Can customize colors, any text graphics, laser printing, heat transfer printing.

Product Selection

Part code	Description
BD-QF02-1	Standard steel cable length is 320mm, can be customized.
BD-QF02-2	

BD-QF03/QF04 ALUMINUM ALLOY STEEL CABLE LEAD SEAL LOCK



Product Features

- Lock body is made of high quality aluminum alloy.
- Lock cable material is high quality aviation steel cable.
- Lock body color can be customized.

Product Selection

Part code	Description
BD-QF03-1	Steel cable: dia. 1.5mm × length 300mm; Max tension: 300kg
BD-QF03-2	Steel cable: dia. 2.0mm × length 300mm; Max tension: 450kg
BD-QF03-3	Steel cable: dia. 2.5mm × length 300mm; Max tension: 500kg
BD-QF03-4	Steel cable: dia. 4.0mm × length 300mm; Max tension: 1000kg
BD-QF03-5	Steel cable: dia. 5.0mm × length 300mm; Max tension: 1200kg
BD-QF04-1	Steel cable: dia. 1.5mm × length 300mm; Max tension: 300kg
BD-QF04-2	Steel cable: dia. 1.8mm × length 300mm; Max tension: 450kg
BD-QF04-3	Steel cable: dia. 2.5mm × length 300mm; Max tension: 500kg
BD-QF04-4	Steel cable: dia. 4.0mm × length 300mm; Max tension: 1000kg
BD-QF04-5	Steel cable: dia. 5.0mm × length 300mm; Max tension: 1200kg

BD-QF05~QF08
HIGH SECURITY BULLET LEAD SEAL LOCK

Unit: mm

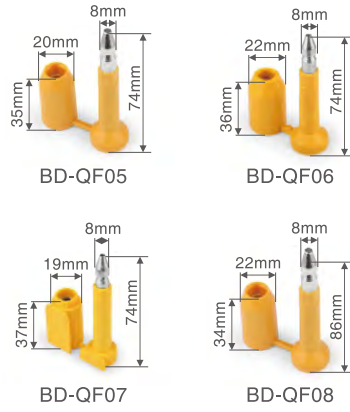

Product Features

- Lock shell material is new ABS eco-friendly plastic.
- Lock rod and barrel are made of Q235 steel, maximum tension can up to 1T.

Product Selection

Part code	Description
BD-QF05	It is suitable for anti-theft locking of trucks and containers.
BD-QF06	
BD-QF07	
BD-QF08	

Steps For Usage

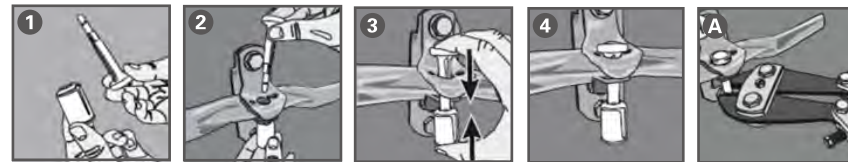

BD-QS01
PLASTIC COATED LAMINATED STEEL CABLE GUN LOCK

Unit: mm

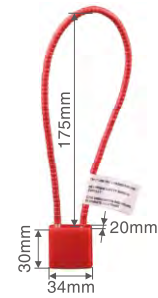

Product Features

- Laminated steel lock body: rubber protective layer prevent the gun body from corrosion wear, solid and durable.
- Application: suitable for most rifles, shotguns, pistols and trigger guns, etc
- Function: keep the gun body locked so that the gun can't be used to prevent accidents.

Product Selection

Model	Cable Size	Application
BD-QS01	Net weight is 0.15KG, with 2 keys.	

APPLICATION

Application



